



MARIA TERESA
ATELIER

MASIERO



MARIA TERESA
ATELIER

MASIERO



MARIA TERESA

La spettacolare magnificenza degli antichi saloni nobiliari di Venezia vive attraverso la collezione Maria Teresa.

La classicità più preziosa mantiene l'iconica estetica, trasformandone la personalità attraverso il fascino creativo delle diverse tipologie di effetto luminoso ottenuto con i sistemi illuminotecnici avanzati.

The Maria Teresa collection brings to life the spectacular magnificence of the rooms in ancient Venetian stately homes.

The precious classical style maintains its original iconic look, but adopts a new personality thanks to the fascinating creativity of a varied range of lighting effects achieved by the latest control systems.



MT_TRADITIONAL

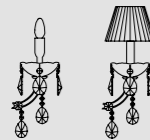

- **Telaio in metallo** con finitura galvanica in colore cromo o oro
- **Braccia** ricoperte in vetro trasparente
- **Bobeches** in vetro trasparente
- **Pendagli** in colore trasparente nelle varianti Half Cut Glass, Cut Crystal e Swarovski
- **Illuminazione** tradizionale con portalamпада attacco E14
- **Apparecchio** dimmerabile a taglio di fase
- **Paralumi** inclusi solo se presenti nella foto. Forma, tessuto e colore come nella foto.

- **Metal frame** in galvanic gold or chrome colour finish
- Transparent **glass arms** coverage
- **Arm's cups** in transparent glass
- **Pendants** in transparent colour in the variations, Half Cut Glass, Cut Crystal, Swarovski
- **Lighting** with bulbs with E14 lamp holder
- Triac dimmable **device**
- **Lampshades** included only when in the picture of the catalogue. Shape, fabric and colour as in the picture.



CG_COLOURED GLASS

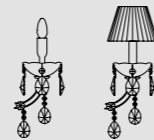

- **Telaio in metallo** verniciato nella palette colori prestabilita
- **Braccia** ricoperte in vetro colorato nella palette colori prestabilita
- **Bobeches** in vetro colorato nella palette colori prestabilita
- **Pendagli** disponibili solo in vetro verniciato nella variante cromatica scelta
- **Illuminazione** tradizionale con portalamпада attacco E14
- **Apparecchio** dimmerabile a taglio di fase
- **Paralumi** inclusi solo se presenti nella foto. Forma, tessuto e colore come nella foto.

- **Metal frame** in powder-coated finish in the pre-established colour palette
- Painted **glass arms** coverage in the pre-established colour palette
- **Arm's cups** in painted glass in the pre-established colour palette
- **Glass pendants** (Half Cut Glass) painted in the pre-established colour variations
- **Lighting** with bulbs with E14 lamp holder
- Triac dimmable **device**
- **Lampshades** included only when in the picture of the catalogue. Shape, fabric and colour as in the picture.



DW_DYNAMIC WHITE



- **Telaio in metallo** con finitura galvanica in colore cromo o oro
- **Braccia** ricoperte in vetro trasparente
- **Bobeches** in vetro trasparente
- **Pendagli** in colore trasparente nelle varianti Half Cut Glass, Cut Crystal e Swarovski
- **Illuminazione** con sorgenti a Led integrato con tecnologia brevettata nella versione Bianco Dinamico DW
- **Luce bianca** compresa tra 2700K e 6500K
- **Apparecchio** gestito con protocollo DMX
- **Disponibile su richiesta** Telecomando

- **Metal frame** in galvanic finish in gold or chrome colour
- Transparent **glass arms** coverage
- **Arm's cups** in transparent glass
- **Pendants** in transparent colour in the variations, Half Cut Glass, Cut Crystal, Swarovski
- **Lighting** with integrated LED sources (technology developed by Masiero) in the White Dynamic DW version
- **White light** between 2700K and 6500K
- **Device** managed with DMX protocol
- **Available on request** Radio Control



RW_RGB-W



- **Telaio in metallo** con finitura galvanica in colore cromo o oro
- **Braccia** ricoperte in vetro trasparente
- **Bobeches** in vetro trasparente
- **Pendagli** in colore trasparente nelle varianti Half Cut Glass, Cut Crystal e Swarovski
- **Illuminazione** con sorgenti a Led integrato con tecnologia brevettata nella versione RGB-W
- **Luce bianca** a 3000K
- **Apparecchio** gestito con protocollo DMX
- **Disponibile su richiesta** APP Masiero Smart Light o Telecomando

- **Metal frame** in galvanic finish in chrome colour
- Transparent **glass arms** coverage
- **Arm's cups** in transparent glass
- **Pendants** in transparent colour in the variations, Half Cut Glass, Cut Crystal, Swarovski
- **Lighting** with integrated LED sources (technology developed by Masiero) in the RGB + White version
- **White light** at 3000K
- **Device** managed with DMX protocol
- **Available on request** APP Masiero Smart Light or Radio Control



DYNAMIC WHITE CONTROL

6000K

2700K

Il sistema **DYNAMIC WHITE Control** è dotato di una centralina* di controllo che consente di gestire tutte le funzioni in base alle esigenze dell'utilizzatore.

The control unit in the **Dynamic White Control** system allows all functions to be managed according to the user's needs.*



RGB-W CONTROL

RGB-W

Il sistema **RGB-W Control** è dotato di una centralina* di controllo che consente di gestire tutte le funzioni in base alle esigenze dell'utilizzatore.

The control unit in the **RGB-W Control** system allows all functions to be managed according to the user's needs.*

*Centralina non inclusa
Control unit not included

Ogni dispositivo **Maria Teresa** può essere integrato nei sistemi domotici di qualsiasi abitazione gestiti con **protocollo DMX**.

*Each **Maria Teresa** device can be integrated into any home automation system managed with the DMX protocol.*

Su richiesta è possibile fornire il dispositivo di uno di questi sistemi di gestione:

On request, the device can be provided with one of the following control systems:

- **RADIOCOMANDO:**

Ogni singolo dispositivo può essere controllato con un radiocomando.

Su richiesta, un unico radiocomando può gestire più dispositivi diversi.

- **RADIO CONTROL:**

Each individual device can be controlled via a radio remote control.

On request, a single remote control can manage several different devices.

- **APP SU SMARTPHONE O TABLET:**

MASIERO ha sviluppato una **APP** disponibile per **sistemi IOS e Android** che, con un'interfaccia semplice ed intuitiva, permette di gestire un numero infinito di dispositivi, contemporaneamente oppure singolarmente.

- **APP ON YOUR SMARTPHONE OR TABLET:**

*MASIERO has developed an **APP** for **IOS** and **Android** systems with a simple, intuitive interface to allow an infinite number of devices to be controlled together or individually.*

RADIO CONNECTION WITH
REMOTE CONTROL

*(Per versione DW e RGB-W)
(For DW and RGB-W version)*



WI-FI CONNECTION WITH
"MASIERO SMART LIGHT" APP

*(Solo per versione RGB-W)
(Only for RGB-W version)*



DMX CONNECTION
WITH DOMOTIC NET

*(Per versione DW e RGB-W)
(For DW and RGB-W version)*



MT TRADITIONAL

Il modello Maria Teresa nella versione classica ricrea la stessa atmosfera degli storici palazzi veneziani. Telaio in metallo disponibile in finitura oro lucido e cromo lucido.

Braccia ricoperte in vetro trasparente e pendagli disponibili in vetro, Cut Crystal o in Swarovski.

The classic version of the Maria Teresa model recreates the atmosphere of historic Venetian stately homes.

The metal frame is available in polished gold or polished chrome.

The arms are covered in clear glass and the pendants are available in glass, cut crystal or Swarovski glass.





DW DYNAMIC WHITE

Il modello Maria Teresa dotato del sistema di illuminazione brevettato LED Bianco Dinamico, permette di personalizzare la temperatura della luce, andando a ricreare il ciclo naturale del sole e scandendo così il ritmo del ciclo circadiano. La luce bianca può essere regolata con una temperatura tra i 2700K e 6500K. Grazie alla tecnologia LED si è pertanto in grado di assecondare l'esigenza di confort e benessere del corpo umano.

In the Maria Teresa model with patented Dynamic White LED lighting system, light temperature can be customised to recreate the natural cycle of the sun, following the rhythm of the circadian cycle. The white light can be adjusted to a temperature between 2700K and 6500K. The LED technology thus makes it possible to provide the comfort and wellness needed by the human body.



VE 951/24 DW



RW RGB-W

La collezione Maria Teresa realizzata con tecnologia brevettata LED RGB-W consente di trasformare la luce in puro colore, rinnovando completamente la percezione visiva dello spazio, che si riempie di infinite sfumature. Le superfici cambiano aspetto e l'ambiente muta secondo desiderio ed umore. E' possibile ottenere anche luce bianca a 3000K.

The Maria Teresa collection with patented RGB-W LED technology, can transform light into pure colour, filling the space with an infinity of hues for a completely new visual perception. Surfaces alter their appearance and the whole ambience changes mood to reflect your personal preferences. White light at 3000K can also be obtained.



VE 907/65 RW



VE 951/24 RW

CG COLOURED GLASS

La collezione Maria Teresa in vetro colorato interpreta un classico senza tempo in chiave contemporanea. Il colore è protagonista assoluto e veste il telaio, le braccia, i paralumi ed i pendagli.

Telaio in metallo verniciato e pendagli in vetro verniciato disponibili in nove colori.

Sistema di illuminazione tradizionale.

The Maria Teresa collection in coloured glass interprets a timeless classic with a contemporary twist.

Colour is the absolute protagonist, adorning the frame, arms, shades and pendants.

The painted metal frame and painted glass pendants are available in a choice of nine colours.

Traditional lighting system.



VE 903/56 CG



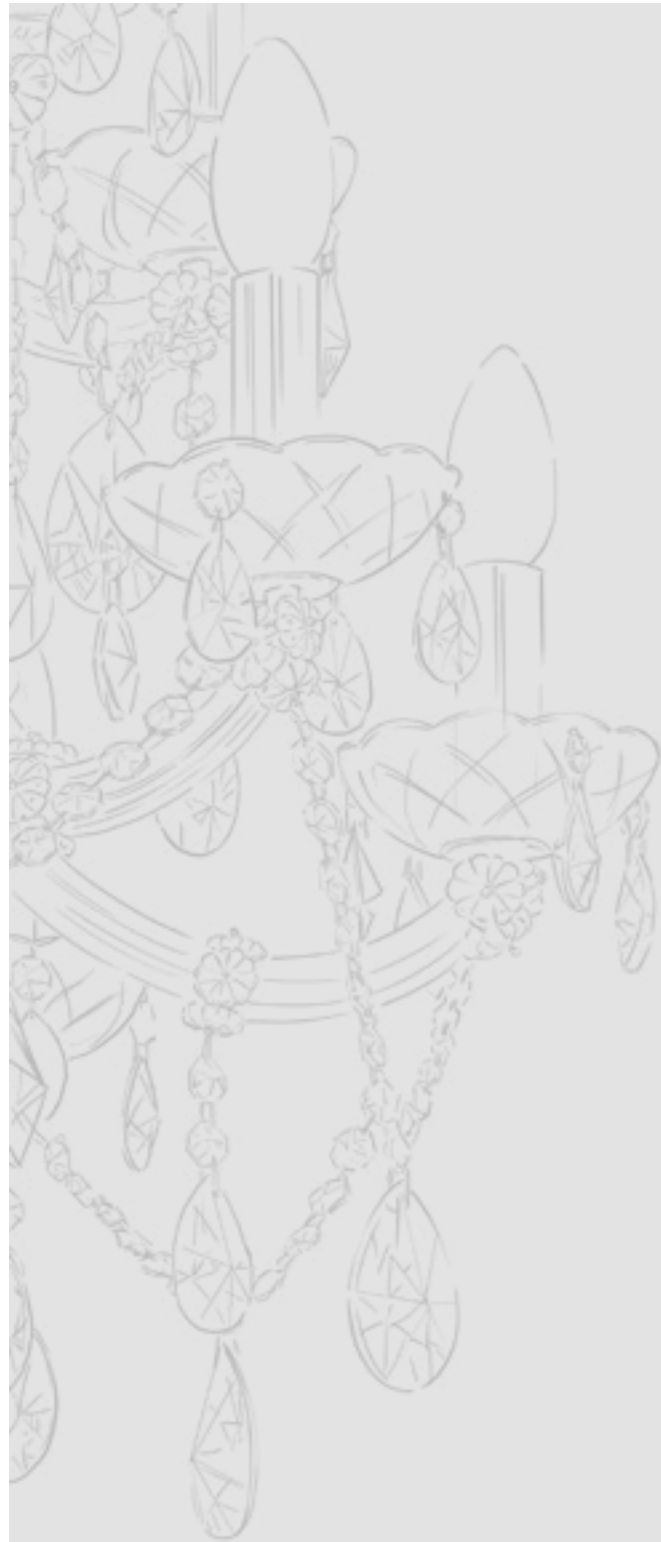

VE 945/18 

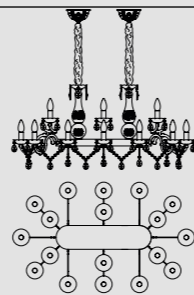

L 107 cm / 42.21"
 SP 65 cm / 25.59"
 H 45 cm / 17.71"
 W 25 kg / 55.11 lb

WW 18×E14×40 W max (not included)
 USA 18×E12×40 W max (not included)
 RW-DW 18×LED source - 72 W tot

VE 945/20 

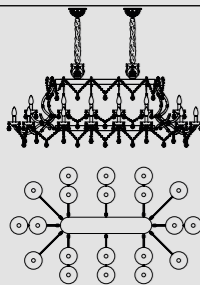

L 153 cm / 60.23"
 SP 93 cm / 36.61"
 H 66 cm / 25.98"
 W 34 kg / 74.95 lb

WW 20×E14×40 W max (not included)
 USA 20×E12×40 W max (not included)
 RW-DW 20×LED - 80 W tot

VE 945/24 

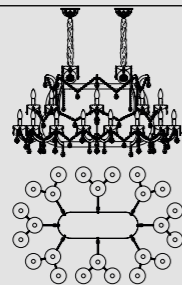

L 129 cm / 50.78"
 SP 88 cm / 34.64"
 H 70 cm / 27.55"
 W 45 kg / 99.20 lb

WW 24×E14×40 W max (not included)
 USA 24×E12×40 W max (not included)
 RW-DW 24×LED - 96 W tot

VE 945/32 

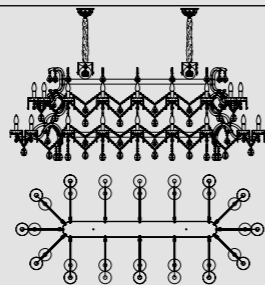

L 200 cm / 78.74"
 SP 88 cm / 34.64"
 H 80 cm / 31.49"
 W 57 kg / 125.66 lb

WW 32×E14×40 W max (not included)
 USA 32×E12×40 W max (not included)
 RW-DW 32×LED - 128 W tot

VE 945/46 

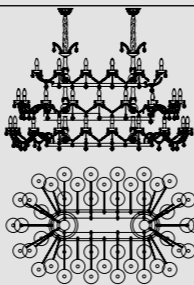

L 192 cm / 75.59"
 SP 114 cm / 44.88"
 H 110 cm / 43.30"
 W 60 kg / 132.27 lb

WW 46×E14×40 W max (not included)
 USA 46×E12×40 W max (not included)
 RW-DW 46×LED - 184 W tot



VE 945/32



| | | |
|---|--|---|
| <p>VE 996/15 CE </p> | <p>VE 996/36 CE </p> | <p>VE 996/48 CE </p> |
| <p>Ø 95 cm / 37.40" H 60 cm / 23.62" W 17 kg / 37.47 lb</p> <p>WW 15×E14×40 W max (not included) USA 15×E12×40 W max (not included)</p> <p>RW-DW 15×LED - source 60 W tot</p> | <p>Ø 165 cm / 64.96" H 95 cm / 37.40" W 48 kg / 105.82 lb</p> <p>WW 36×E14×40 W max (not included) USA 36×E12×40 W max (not included)</p> <p>RW-DW 36×LED - source 144 W tot</p> | <p>Ø 210 cm / 82.67" H 110 cm / 43.30" W 95 kg / 209.43 lb</p> <p>WW 48×E14×40 W max (not included) USA 48×E12×40 W max (not included)</p> <p>RW-DW 48×LED - source 192 W tot</p> |

VE 996/36



VE 961/8 

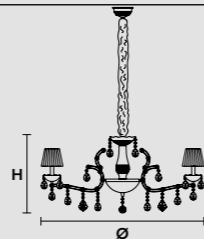

Ø 75 cm / 29.52"
 H 42 cm / 16.53"
 W 11 kg / 24.25 lb
 WW 8×E14×40 W max (not included)
 USA 8×E12×40 W max (not included)
 RW-DW 8×LED source-32 W tot

VE 961/10 

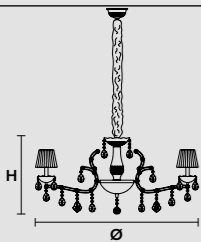

Ø 85 cm / 33.46"
 H 42 cm / 16.53"
 W 17 kg / 37.47 lb
 WW 10×E14×40 W max (not included)
 USA 10×E12×40 W max (not included)
 RW-DW 10×LED source-40 W tot

VE 961/12 

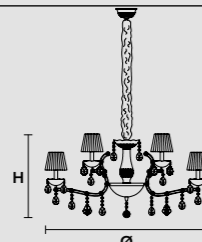

Ø 75 cm / 29.52"
 H 60 cm / 23.62"
 W 16 kg / 35.27 lb
 WW 12×E14×40 W max (not included)
 USA 12×E12×40 W max (not included)
 RW-DW 12×LED source-48 W tot

VE 961/15 

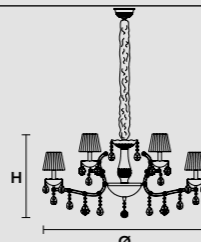

Ø 85 cm / 33.46"
 H 60 cm / 23.62"
 W 22 kg / 48.50 lb
 WW 15×E14×40 W max (not included)
 USA 15×E12×40 W max (not included)
 RW-DW 15×LED source-60 W tot

VE 961/24 

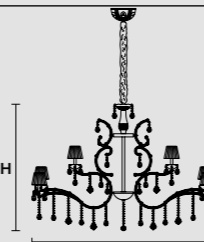

Ø 150 cm / 59.05"
 H 105 cm / 41.33"
 W 40 kg / 88.18 lb
 WW 24×E14×40 W max (not included)
 USA 24×E12×40 W max (not included)
 RW-DW 24×LED source-576 W tot



VE 961/8



VE 921/24 

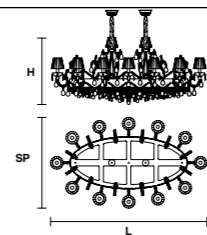

L 150 cm / 59.06"
SP 85 cm / 33.46"
H 68 cm / 26.77"
W 43 kg / 94.79 lb

WW 12×E14×40 W max (not included)
 12×E27×60 W max (not included)
USA 12×E12×40 W max (not included)
 12×E26×60 W max (not included)

RW-DW 24×LED source -56 W tot

VE 921/32 

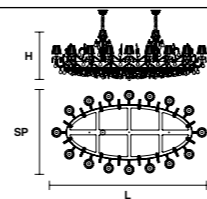

L 200 cm / 78.74"
SP 110 cm / 43.30"
H 65 cm / 25.59"
W 60 kg / 132.27 lb

WW 16×E14×40 W max (not included)
 16×E27×60 W max (not included)
USA 16×E12×40 W max (not included)
 16×E26×60 W max (not included)

RW-DW 32×LED source -96 W tot

VE 921/ 24

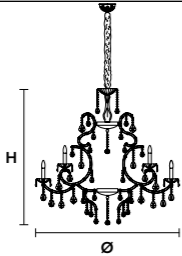
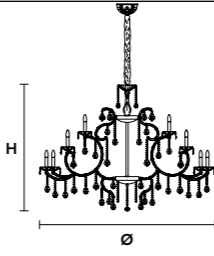
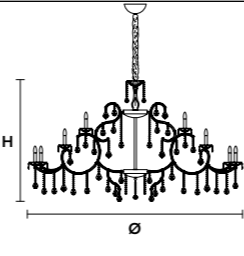

| VE 998/18 | VE 998/40 | VE 998/56 |
|---|---|---|
|  |  |  |
| Ø 125 cm / 49.21" H 130 cm / 51.18" W 30 kg / 66.13 lb | Ø 170 cm / 66.92" H 120 cm / 47.24" W 60 kg / 132.27 lb | Ø 215 cm / 84.64" H 120 cm / 47.24" W 120 kg / 264.5 lb |
| WW 18×E14×40 W max (not included) USA 18×E12×40 W max (not included) | WW 40×E14×40 W max (not included) USA 40×E12×40 W max (not included) | WW 56×E14×40 W max (not included) USA 56×E12×40 W max (not included) |
| RW-DW 18×LED source - 72 W tot | RW-DW 40×LED source - 160 W | RW-DW 56×LED source - 224 W |

VE 998/18



VE 992/18 

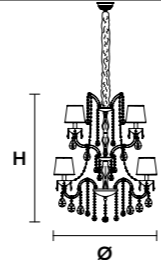

| | |
|---|------------------|
| Ø | 85 cm / 33.46" |
| H | 100 cm / 39.37" |
| W | 25 kg / 55.11 lb |

WW 18×E14×40 W max (not included)
 USA 18×E12×40 W max (not included)

RW-DW 18×LED source - 72 W tot

VE 992/18

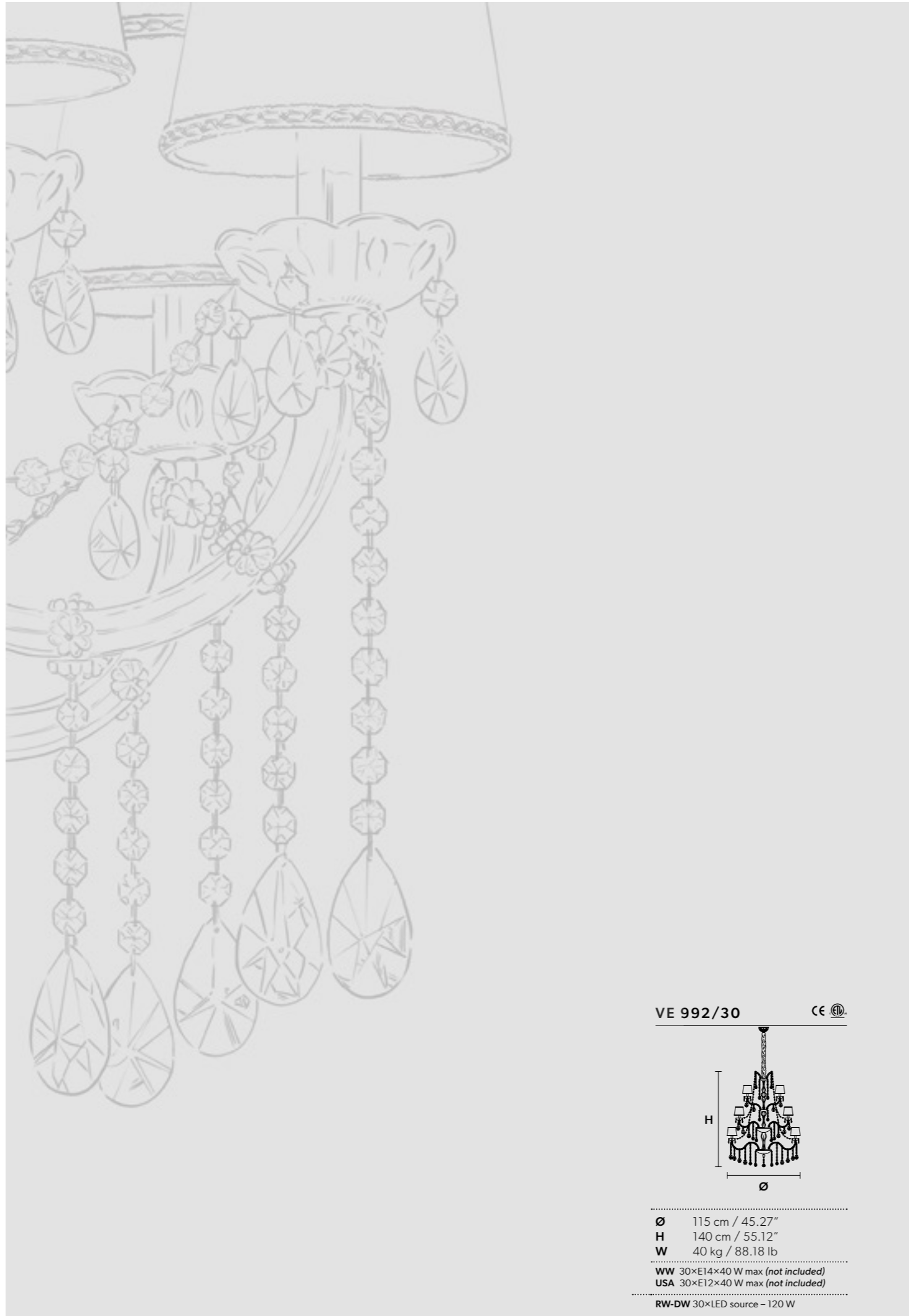

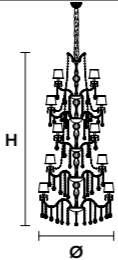
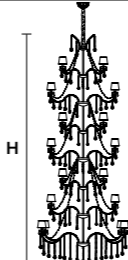

| VE 992/48 | CE | VE 992/70 | CE |
|---|----|---|----|
|  | |  | |
| Ø 120 cm / 47.24" | | Ø 150 cm / 59.05" | |
| H 240 cm / 94.49" | | H 380 cm / 149.60" | |
| W 80 kg / 176.37 lb | | W 100 kg / 220.4 lb | |
| WW 48×E14×40 W max (not included) | | WW 70×E14×40 W max (not included) | |
| USA 48×E12×40 W max (not included) | | USA 70×E12×40 W max (not included) | |
| RW-DW 48×LED source - 72 W tot | | RW-DW 70×LED source - 120 W | |

VE 992/48



VE 986/15

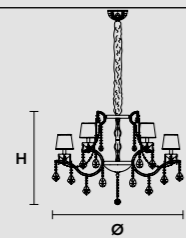

Ø 95 cm / 37.40"
H 70 cm / 27.55"
W 18 kg / 39.68 lb

WW 15×E14×40 W max (not included)
USA 15×E12×40 W max (not included)

RW-DW 15×LED source – 60 W tot

VE 986/18

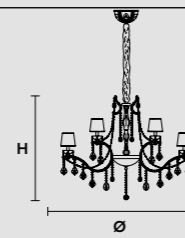

Ø 135 cm / 53.14"
H 90 cm / 35.43"
W 30 kg / 66.13 lb

WW 18×E14×40 W max (not included)
USA 18×E12×40 W max (not included)

RW-DW 18×LED source – 72 W tot

VE 986/39

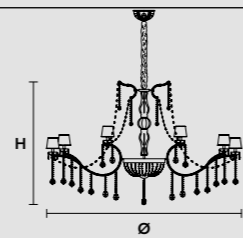

Ø 190 cm / 74.80"
H 125 cm / 49.21"
W 70 kg / 154.32 lb

WW 39×E14×40 W max (not included)
USA 39×E12×40 W max (not included)

RW-DW 39×LED source – 156 W



VE 986/18

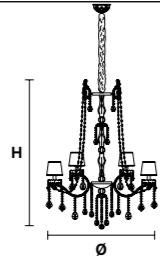
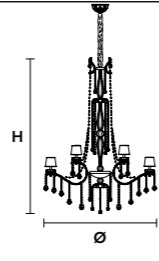
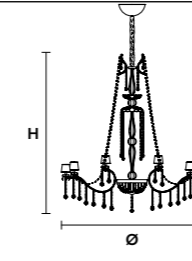

| VE 987/15 | VE 987/18 | VE 987/39 |
|--|---|---|
|  |  |  |
| Ø 95 cm / 37.40" H 130 cm / 51.18" W 20 kg / 44.09 lb WW 15×E14×40 W max (not included) USA 15×E12×40 W max (not included) RW-DW 15×LED source – 60 W tot | Ø 140 cm / 55.11" H 200 cm / 78.74" W 38 kg / 83.77 lb WW 18×E14×40 W max (not included) USA 18×E12×40 W max (not included) RW-DW 18×LED source – 72 W tot | Ø 190 cm / 74.80" H 210 cm / 82.67" W 80 kg / 176.37 lb WW 39×E14×40 W max (not included) USA 39×E12×40 W max (not included) RW-DW 39×LED source – 156 W |

VE 987/18



VE 906/15 CE VE 906/32 CE VE 906/42 CE VE 906/49 CE

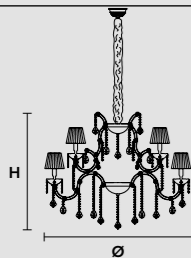

Ø 100 cm / 39.37"
 H 78 cm / 30.37"
 W 25 kg / 55.11 lb
 WW 15×E14×40 W max (not included)
 USA 15×E12×40 W max (not included)
 RW-DW 15×LED source - 60 W tot

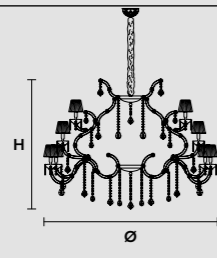

Ø 125 cm / 49.21"
 H 90 cm / 35.43"
 W 40 kg / 88.18 lb
 WW 32×E14×40 W max (not included)
 USA 32×E12×40 W max (not included)
 RW-DW 32×LED source - 128 W tot

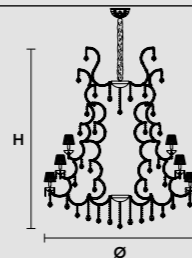

Ø 150 cm / 59.05"
 H 180 cm / 70.86"
 W 75 kg / 165.34 lb
 WW 42×E14×40 W max (not included)
 USA 42×E12×40 W max (not included)
 RW-DW 42×LED source - 168 W tot

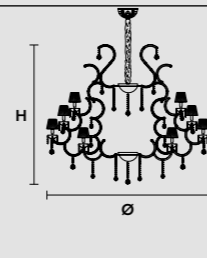

Ø 190 cm / 74.80"
 H 170 cm / 66.92"
 W 90 kg / 198.41 lb
 WW 49×E14×40 W max (not included)
 USA 49×E12×40 W max (not included)
 RW-DW 49×LED source - 196 W tot



VE 906/49 CG



VE 905/15 CE VE 905/24 CE VE 905/56 CE

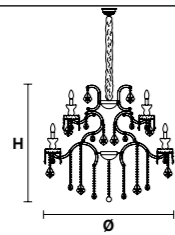

Ø 90 cm / 35.43"
 H 80 cm / 31.49"
 W 38 kg / 83.77 lb
 WW 15×E14×40 W max (not included)
 USA 15×E12×40 W max (not included)
 RW-DW 15×LED source - 60 W tot

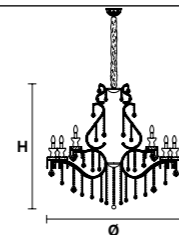

Ø 145 cm / 57.08"
 H 120 cm / 47.24"
 W 60 kg / 132.27 lb
 WW 24×E14×40 W max (not included)
 USA 24×E12×40 W max (not included)
 RW-DW 24×LED source - 96 W tot

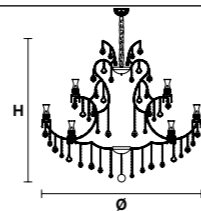

Ø 210 cm / 102.40"
 H 195 cm / 118.20"
 W 140 kg / 308.6 lb
 WW 56×E14×40 W max (not included)
 USA 56×E12×40 W max (not included)
 RW-DW 56×LED source - 224 W tot

VE 905/56



| | | |
|--|--|---|
| <p>VE 991/15 CE </p> | <p>VE 991/24 CE </p> | <p>VE 991/36 CE </p> |
| <p>Ø 95 cm / 37.40" H 65 cm / 25.59" W 17 kg / 37.47 lb</p> <p>WW 15×E14×40 W max (not included) USA 15×E12×40 W max (not included)</p> <p>RW-DW 15×LED source - 60 W tot</p> | <p>Ø 140 cm / 55.11" H 100 cm / 39.37" W 30 kg / 66.13 lb</p> <p>WW 24×E14×40 W max (not included) USA 24×E12×40 W max (not included)</p> <p>RW-DW 24×LED source - 96 W tot</p> | <p>Ø 165 cm / 64.96" H 95 cm / 37.40" W 50 kg / 110.23 lb</p> <p>WW 36×E14×40 W max (not included) USA 36×E12×40 W max (not included)</p> <p>RW-DW 36×LED source - 224 W tot</p> |

VE 991/24



VE 973/70 

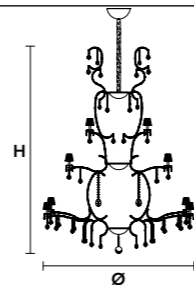

Ø 290 cm / 114.17"
H 300 cm / 118.20"
W 135 kg / 297.6 lb
WW 70×E14×40 W max (not included)
USA 70×E12×40 W max (not included)
RW-DW 70×LED source -280 W tot



VE 910/25 

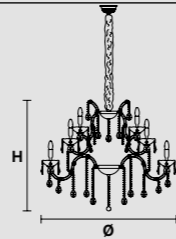

Ø 100 cm / 39.37"
 H 75 cm / 29.52"
 W 26 kg / 57.32 lb

WW 25×E14×40 W max (not included)
 USA 25×E12×40 W max (not included)

RW-DW 25×LED source -100 W tot

VE 910/32 

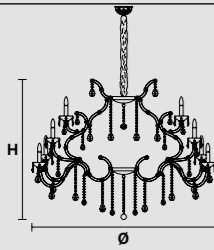

Ø 125 cm / 49.21"
 H 90 cm / 35.43"
 W 40 kg / 88.18 lb

WW 32×E14×40 W max (not included)
 USA 32×E12×40 W max (not included)

RW-DW 32×LED source -128 W tot

VE 910/42 

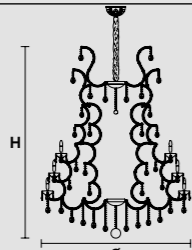

Ø 150 cm / 59.05"
 H 180 cm / 70.87"
 W 70 kg / 154.32 lb

WW 42×E14×40 W max (not included)
 USA 42×E12×40 W max (not included)

RW-DW 42×LED source -168 W tot

VE 910/49 

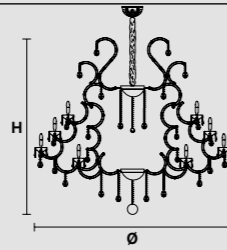

Ø 185 cm / 72.83"
 H 165 cm / 64.96"
 W 85 kg / 187.39 lb

WW 49×E14×40 W max (not included)
 USA 49×E12×40 W max (not included)

RW-DW 49×LED source -196 W tot

VE 910/56 

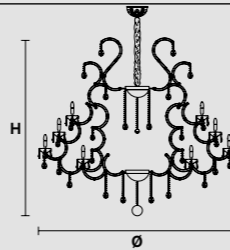

Ø 185 cm / 72.83"
 H 165 cm / 64.96"
 W 100 kg / 220.5 lb

WW 56×E14×40 W max (not included)
 USA 56×E12×40 W max (not included)

RW-DW 56×LED source -224 W tot



VE 910/56



VE 929/24 CE VE 929/36 CE

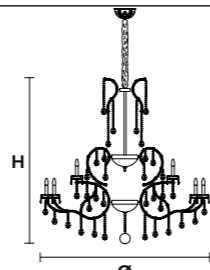
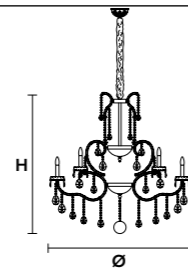

Ø 120 cm / 47.24"
 H 120 cm / 47.24"
 W 57 kg / 125.66 lb

Ø 165 cm / 64.96"
 H 160 cm / 62.99"
 W 90 kg / 198.41 lb

WW 24×E14×40 W max (not included)
 USA 24×E12×40 W max (not included)

WW 36×E14×40 W max (not included)
 USA 36×E12×40 W max (not included)

RW-DW 24×LED source -96 W tot

RW-DW 36×LED source -144 W tot

VE 929/24



VE 981/12 

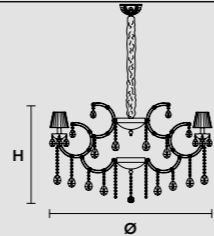

Ø 106 cm / 41.73"
 H 70 cm / 27.55"
 W 20 kg / 44.09 lb

WW 12×E14×40 W max (not included)
 USA 12×E12×40 W max (not included)

RW-DW 12×LED source - 48 W tot



VE 981/12



VE 981/24 

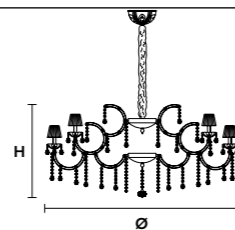

Ø 140 cm / 55.11"
H 70 cm / 27.55"
W 40 kg / 88.18 lb

WW 24×E14×40 W max (not included)
USA 24×E12×40 W max (not included)

RW-DW 24×LED source -96 W tot

VE 981/60 

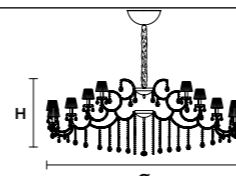

Ø 220 cm / 86.61"
H 75 cm / 29.52"
W 72 kg / 158.73 lb

WW 60×E14×40 W max (not included)
USA 60×E12×40 W max (not included)

RW-DW 60×LED source - 240 W

VE 981/24 RW

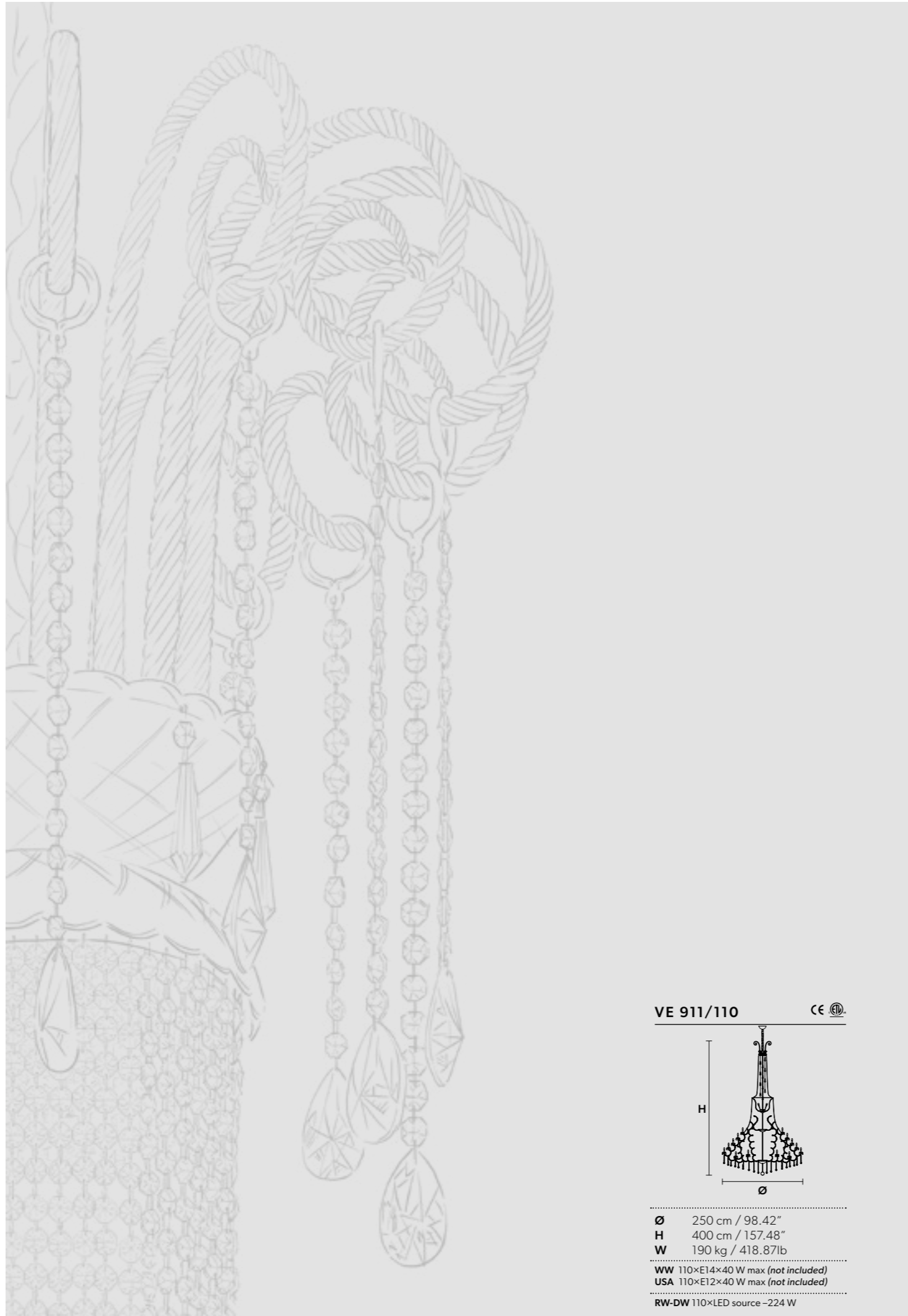



VE 911/25 CE VE 911/32 CE VE 911/45 CE VE 911/56 CE

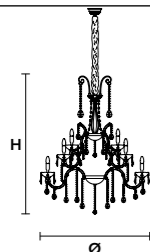

Ø 100 cm / 39.37"
 H 160 cm / 62.99"
 W 30 kg / 66.13 lb
 WW 25×E14×40 W max (not included)
 USA 25×E12×40 W max (not included)
 RW-DW 25×LED source -60 W tot

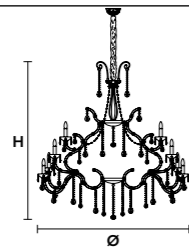

Ø 125 cm / 49.21"
 H 170 cm / 66.92"
 W 45 kg / 99.20 lb
 WW 32×E14×40 W max (not included)
 USA 32×E12×40 W max (not included)
 RW-DW 32×LED source -128 W tot

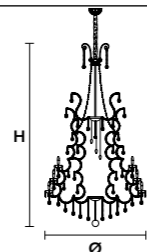

Ø 150 cm / 59.05"
 H 270 cm / 106.29"
 W 80 kg / 176.36 lb
 WW 45×E14×40 W max (not included)
 USA 45×E12×40 W max (not included)
 RW-DW 45×LED source -168 W tot

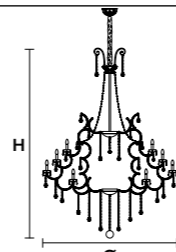

Ø 185 cm / 72.83"
 H 240 cm / 94.48"
 W 110 kg / 242.5 lb
 WW 56×E14×40 W max (not included)
 USA 56×E12×40 W max (not included)
 RW-DW 56×LED source -196 W tot

VE 911/56



| VE 920/14 | CE | VE 920/24 | CE | VE 920/30 | CE |
|---|----|---|----|---|----|
| | | | | | |
| L 90 cm / 35.43" | | L 160 cm / 62.99" | | L 200 cm / 78.74" | |
| SP 45 cm / 17.72" | | SP 70 cm / 27.55" | | SP 70 cm / 27.55" | |
| H 50 cm / 19.69" | | H 60 cm / 23.62" | | H 60 cm / 23.62" | |
| W 48 kg / 105.82 lb | | W 77.5 kg / 170.8 lb | | W 100 kg / 220.4 lb | |
| WW 14×E14×40 W max (not included) | | WW 24×E14×40 W max (not included) | | WW 30×E14×40 W max (not included) | |
| USA 14×E12×40 W max (not included) | | USA 24×E12×40 W max (not included) | | USA 30×E12×40 W max (not included) | |
| RW-DW 14×LED source -56 W tot | | RW-DW 24×LED source -96 W tot | | RW-DW 30×LED source -120 W tot | |



VE 920/24

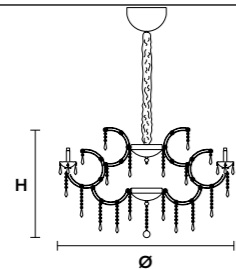
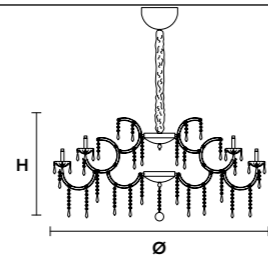
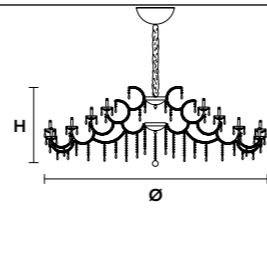

| VE 980/12 | VE 980/24 | VE 980/60 |
|---|---|---|
|  |  |  |
| <p>Ø 106 cm / 41.73"</p> <p>H 70 cm / 27.55"</p> <p>W 16 kg / 35.27 lb</p> <p>WW 12×E14×40 W max (not included)</p> <p>USA 12×E12×40 W max (not included)</p> <p>RW-DW 12×LED source – 48 W tot</p> | <p>Ø 140 cm / 55.11"</p> <p>H 70 cm / 27.55"</p> <p>W 37 kg / 81.57 lb</p> <p>WW 24×E14×40 W max (not included)</p> <p>USA 24×E12×40 W max (not included)</p> <p>RW-DW 24×LED source – 96 W tot</p> | <p>Ø 220 cm / 86.61"</p> <p>H 75 cm / 29.52"</p> <p>W 67 kg / 147.70 lb</p> <p>WW 60×E14×40 W max (not included)</p> <p>USA 60×E12×40 W max (not included)</p> <p>RW-DW 60×LED source – 240 W</p> |

VE 980/24

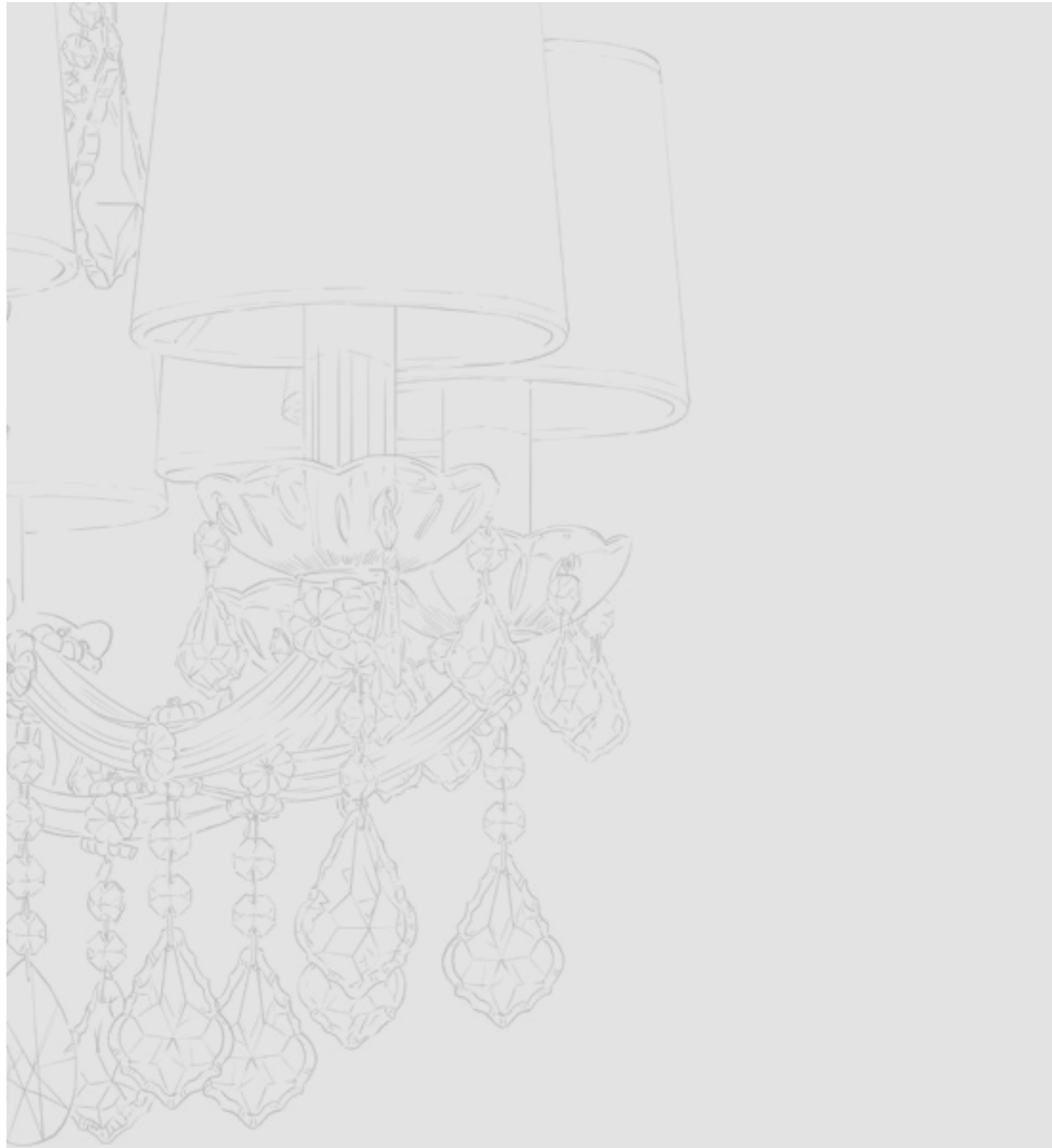

VE 915/12 CE VE 915/36 CE VE 915/48 CE

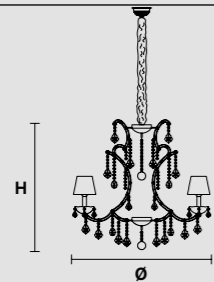

Ø 95 cm / 37.40"
 H 82 cm / 32.28"
 W 25 kg / 55.11 lb
 WW 12×E14×40 W max (not included)
 USA 12×E12×40 W max (not included)
 RW-DW 12×LED source – 48 W tot

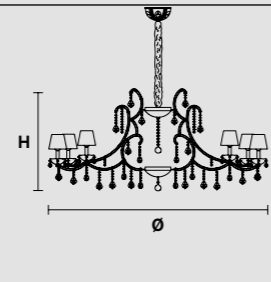

Ø 170 cm / 66.92"
 H 90 cm / 35.43"
 W 60 kg / 132.27 lb
 WW 36×E14×40 W max (not included)
 USA 36×E12×40 W max (not included)
 RW-DW 36×LED source – 144 W

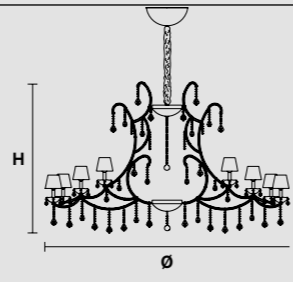

Ø 205 cm / 80.70"
 H 140 cm / 55.11"
 W 95 kg / 209.43 lb
 WW 48×E14×40 W max (not included)
 USA 48×E12×40 W max (not included)
 RW-DW 48×LED source – 192

VE 915/12



VE 988/32 

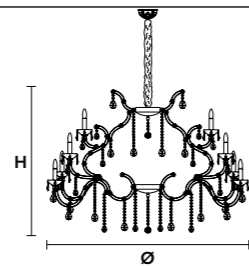

Ø 130 cm / 51.18"
 H 90 cm / 35.43"
 W 30 kg / 66.13 lb

WW 32×E14×40 W max (not included)
 USA 32×E12×40 W max (not included)

RW-DW 32×LED source -128 W tot

VE 988/48 

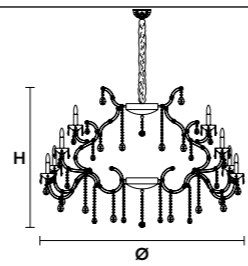

Ø 130 cm / 51.18"
 H 90 cm / 35.43"
 W 51 kg / 112.43 lb

WW 48×E14×40 W max (not included)
 USA 48×E12×40 W max (not included)

RW-DW 48×LED source -192 W tot

VE 988/48



VE 984/12 

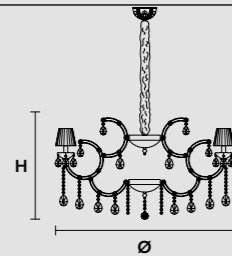

Ø 106 cm / 41.73"
 H 70 cm / 27.55"
 W 18 kg / 39.68 lb
 WW 12×E14×40 W max (not included)
 USA 12×E12×40 W max (not included)
 RW-DW 12×LED source – 48 W tot

VE 984/24 

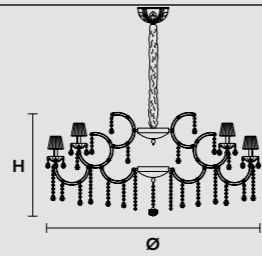

Ø 140 cm / 55.11"
 H 70 cm / 27.55"
 W 37 kg / 81.57 lb
 WW 24×E14×40 W max (not included)
 USA 24×E12×40 W max (not included)
 RW-DW 24×LED source – 96 W tot

VE 984/60 

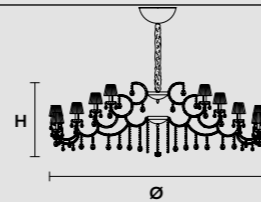

Ø 220 cm / 86.61"
 H 75 cm / 29.52"
 W 69 kg / 152.11 lb
 WW 60×E14×40 W max (not included)
 USA 60×E12×40 W max (not included)
 RW-DW 60×LED source – 240 W

VE 984/60

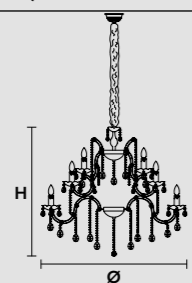
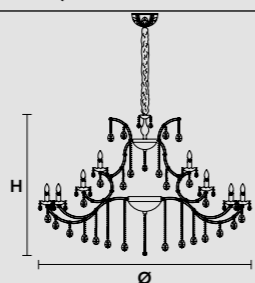
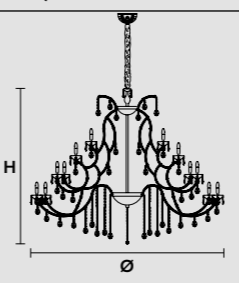

| VE 918/30 | VE 918/48 | VE 918/72 |
|---|---|---|
|  |  |  |
| <p>Ø 100 cm / 39.37"</p> <p>H 90 cm / 35.43"</p> <p>W 28 kg / 61.72 lb</p> <p>WW 30×E14×40 W max (not included)</p> <p>USA 30×E12×40 W max (not included)</p> <p>RW-DW 30×LED source -120 W tot</p> | <p>Ø 165 cm / 64.96"</p> <p>H 110 cm / 43.30"</p> <p>W 50 kg / 110.23 lb</p> <p>WW 48×E14×40 W max (not included)</p> <p>USA 48×E12×40 W max (not included)</p> <p>RW-DW 48×LED source -192 W tot</p> | <p>Ø 200 cm / 78.74"</p> <p>H 160 cm / 62.99"</p> <p>W 90 kg / 198.41 lb</p> <p>WW 72×E14×40 W max (not included)</p> <p>USA 72×E12×40 W max (not included)</p> <p>RW-DW 72×LED source -288 W tot</p> |

VE 918/30



VE 931/12 CE

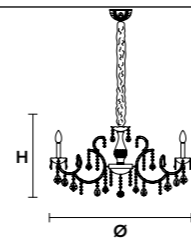

Ø 100 cm / 39.37"
 H 46 cm / 18.11"
 W 18 kg / 39.68 lb

WW 12×E14×40 W max (not included)
 USA 12×E12×40 W max (not included)

RW-DW 12×LED source - 48 W tot

VE 931/12



VE 934/12 

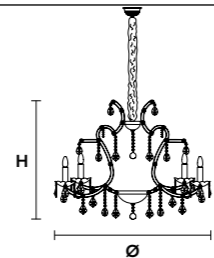

Ø 95 cm / 37.40"
H 80 cm / 31.49"
W 17 kg / 37.47 lb
WW 12×E14×40 W max (not included)
USA 12×E12×40 W max (not included)
RW-DW 12×LED source – 48 W tot

VE 934/40 

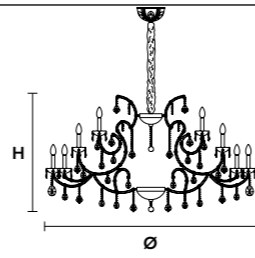

Ø 150 cm / 59.05"
H 95 cm / 37.40"
W 50 kg / 110.23 lb
WW 40×E14×40 W max (not included)
USA 40×E12×40 W max (not included)
RW-DW 40×LED source – 160 W

VE 934/40



VE 950/18 

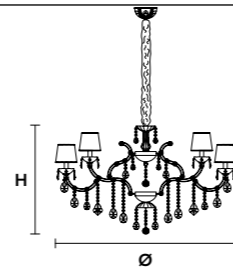

- Ø 105 cm / 41.33"
- H 65 cm / 25.59"
- W 18 kg / 39.68 lb

WW 18×E14×40 W max (not included)
 USA 18×E12×40 W max (not included)

RW-DW 18×LED source - 72 W tot

VE 950/18



VE 917/15 CE

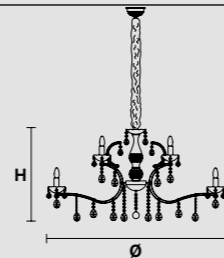

Ø 85 cm / 33.46"
H 60 cm / 23.62"
W 18 kg / 39.68 lb

WW 15×E14×40 W max (not included)
USA 15×E12×40 W max (not included)

RW-DW 15×LED source - 60 W tot



VE 917/15



VE 975/16 

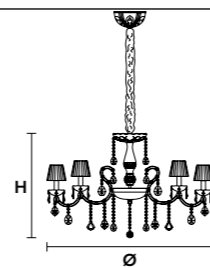



Ø 110 cm / 43.31"
H 70 cm / 27.55"
W 28 kg / 61.72 lb

WW 16×E14×40 W max (not included)
USA 16×E12×40 W max (not included)

RW-DW 16×LED source - 64 W tot

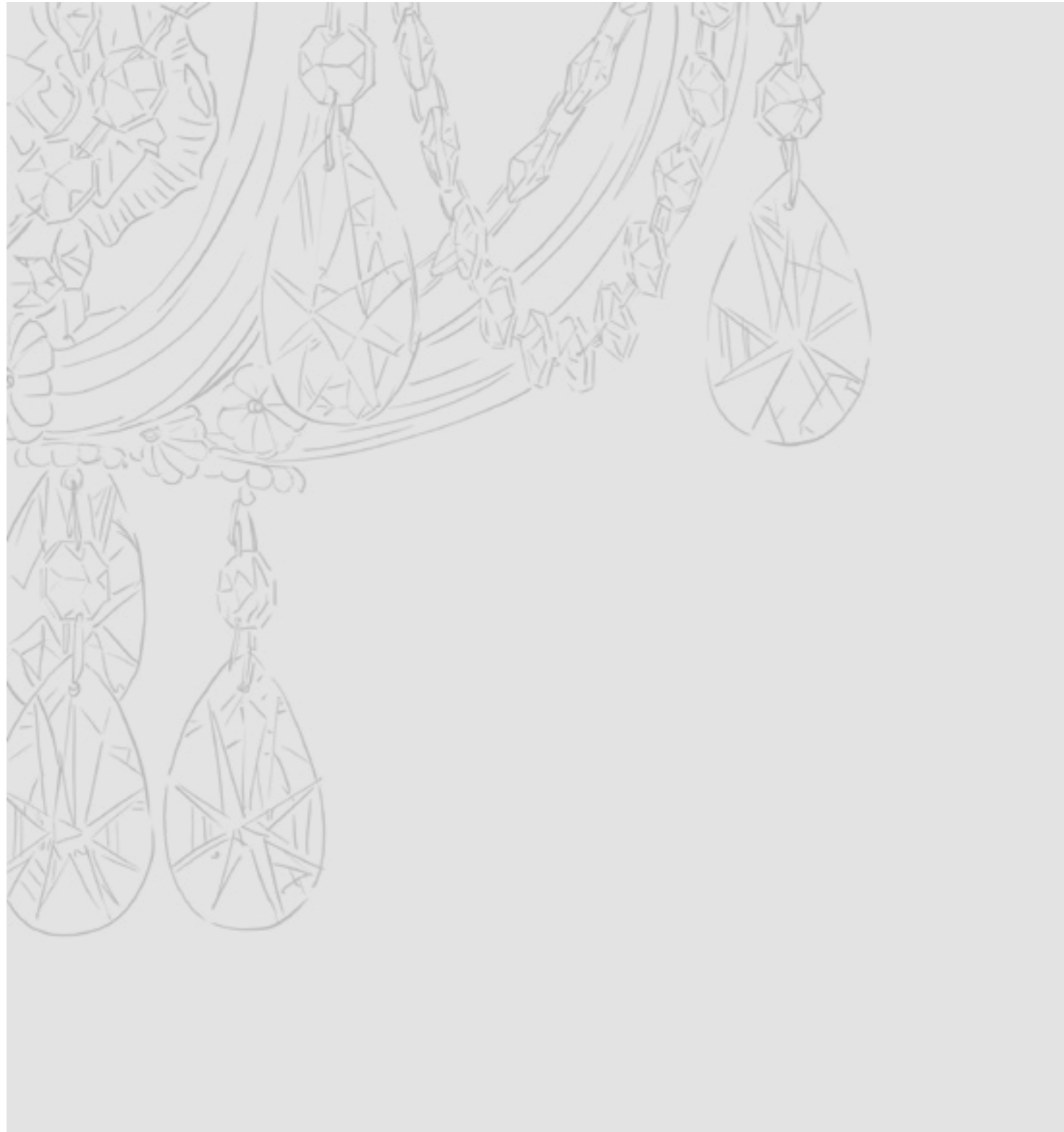
VE 975/16



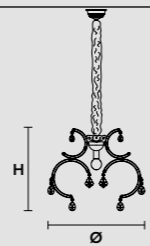

VE 956/1 CE 

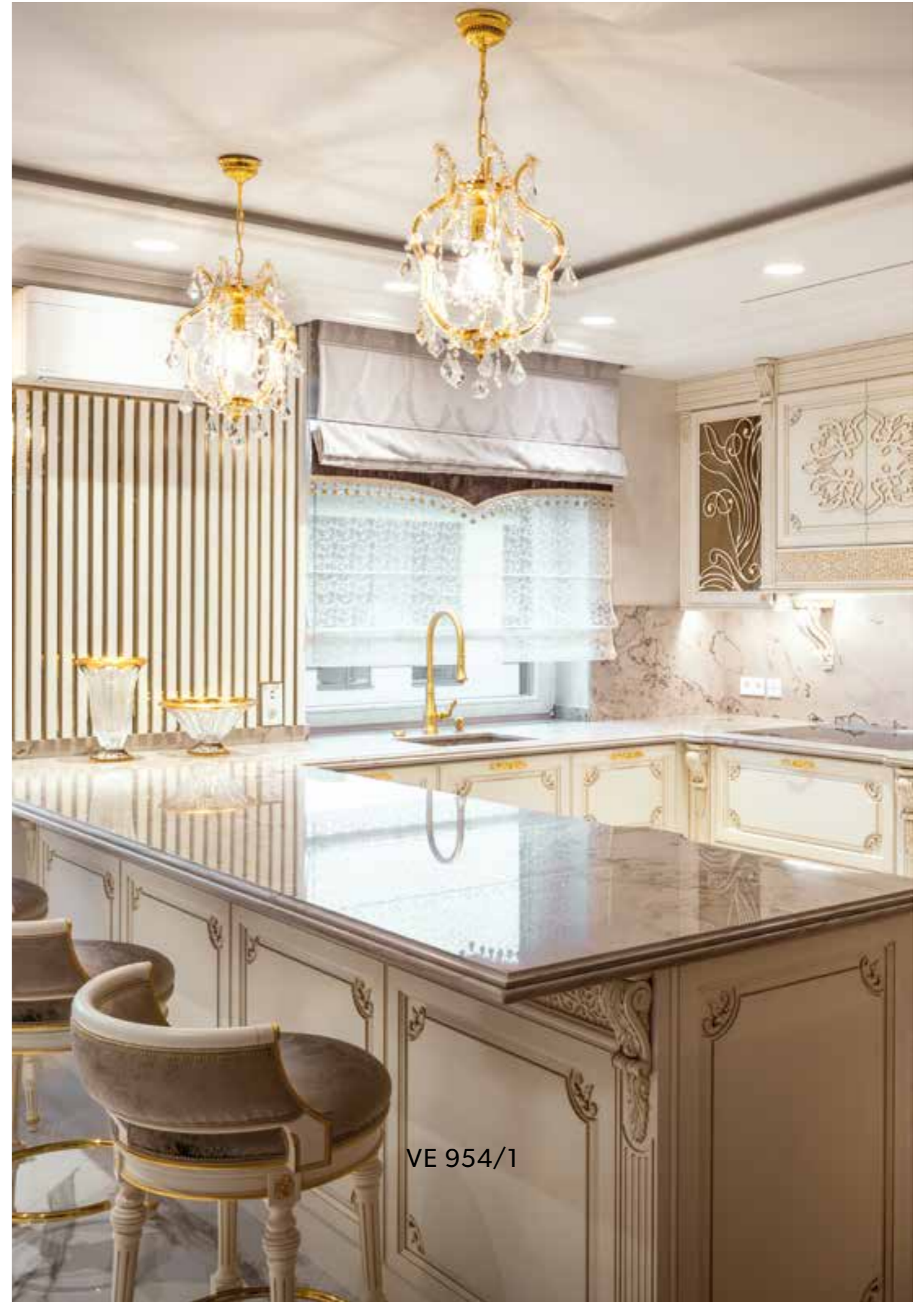

Ø 40 cm / 15.75"
 H 40 cm / 15.75"
 W 7 kg / 15.43 lb
 WW 1xE27x60 W max (not included)
 USA 1xE26x60 W max (not included)
 RW-DW 1xLED source -4 W tot

VE 956/1



VE 954/1 CE 

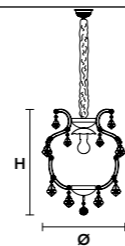

Ø 40 cm / 15.75"
H 50 cm / 19.69"
W 6 kg / 13.22 lb
WW 1x E27x60 W max (not included)
USA 1x E26x60 W max (not included)
RW-DW 1x LED source - 4 W tot

VE 954/1



VE 940/5 

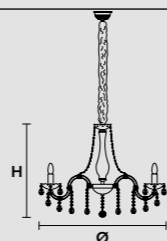

Ø 60 cm / 23.62"
 H 50 cm / 19.68"
 W 7 kg / 15.43 lb
 WW 5×E14×40 W max (not included)
 USA 5×E12×40 W max (not included)
 RW-DW 5×LED source – 20 W tot

VE 940/8 

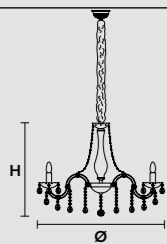

Ø 62 cm / 24.40"
 H 50 cm / 19.68"
 W 8.3 kg / 18.29 lb
 WW 8×E14×40 W max (not included)
 USA 8×E12×40 W max (not included)
 RW-DW 8×LED source – 32 W tot

VE 940/12 

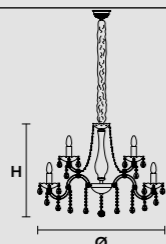

Ø 65 cm / 25.59"
 H 57 cm / 22.44"
 W 12 kg / 26.45 lb
 WW 12×E14×40 W max (not included)
 USA 12×E12×40 W max (not included)
 RW-DW 12×LED source – 48 W tot

VE 940/18 

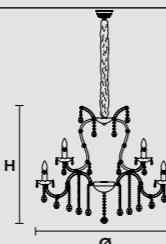

Ø 105 cm / 41.33"
 H 85 cm / 33.46"
 W 25 kg / 55.11 lb
 WW 18×E14×40 W max (not included)
 USA 18×E12×40 W max (not included)
 RW-DW 18×LED source – 72 W tot

VE 940/24 

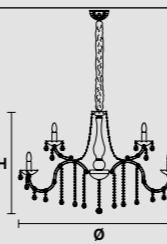

Ø 100 cm / 39.37"
 H 70 cm / 27.55"
 W 20 kg / 44.09 lb
 WW 24×E14×40 W max (not included)
 USA 24×E12×40 W max (not included)
 RW-DW 24×LED source – 96 W tot



VE 940/5



| | | | |
|--|----|---|----|
| VE 944/3 | CE | VE 944/5 | CE |
| | | | |
| <p>Ø 47 cm / 18.50"</p> <p>H 42 cm / 16.53"</p> <p>W 3.5 kg / 7.71 lb</p> <p>WW 3×E14×40 W max (not included)</p> <p>USA 3×E12×40 W max (not included)</p> <p>RW-DW 3×LED source -12 W tot</p> | | <p>Ø 47 cm / 18.50"</p> <p>H 42 cm / 16.53"</p> <p>W 5 kg / 11.02 lb</p> <p>WW 5×E14×40 W max (not included)</p> <p>USA 5×E12×40 W max (not included)</p> <p>RW-DW 5×LED source -20 W tot</p> | |

VE 944/5

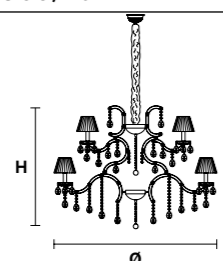
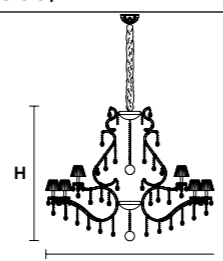
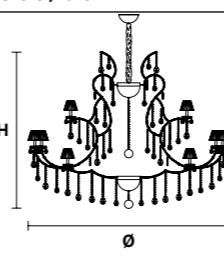

| VE 903/15 | VE 903/24 | VE 903/56 |
|--|---|--|
|  |  |  |
| <p>Ø 90 cm / 35.43"</p> <p>H 70 cm / 27.55"</p> <p>W 30 kg / 66.13 lb</p> <p>WW 15×E14×40 W max (not included)</p> <p>USA 15×E12×40 W max (not included)</p> <p>RW-DW 15×LED source - 60 W tot</p> | <p>Ø 150 cm / 59.05"</p> <p>H 120 cm / 47.24"</p> <p>W 48 kg / 105.82 lb</p> <p>WW 24×E14×40 W max (not included)</p> <p>USA 24×E12×40 W max (not included)</p> <p>RW-DW 24×LED source - 96 W tot</p> | <p>Ø 210 cm / 82.67"</p> <p>H 180 cm / 70.86"</p> <p>W 140 kg / 308.6 lb</p> <p>WW 56×E14×40 W max (not included)</p> <p>USA 56×E12×40 W max (not included)</p> <p>RW-DW 56×LED source - 224</p> |

VE 903/56 CG

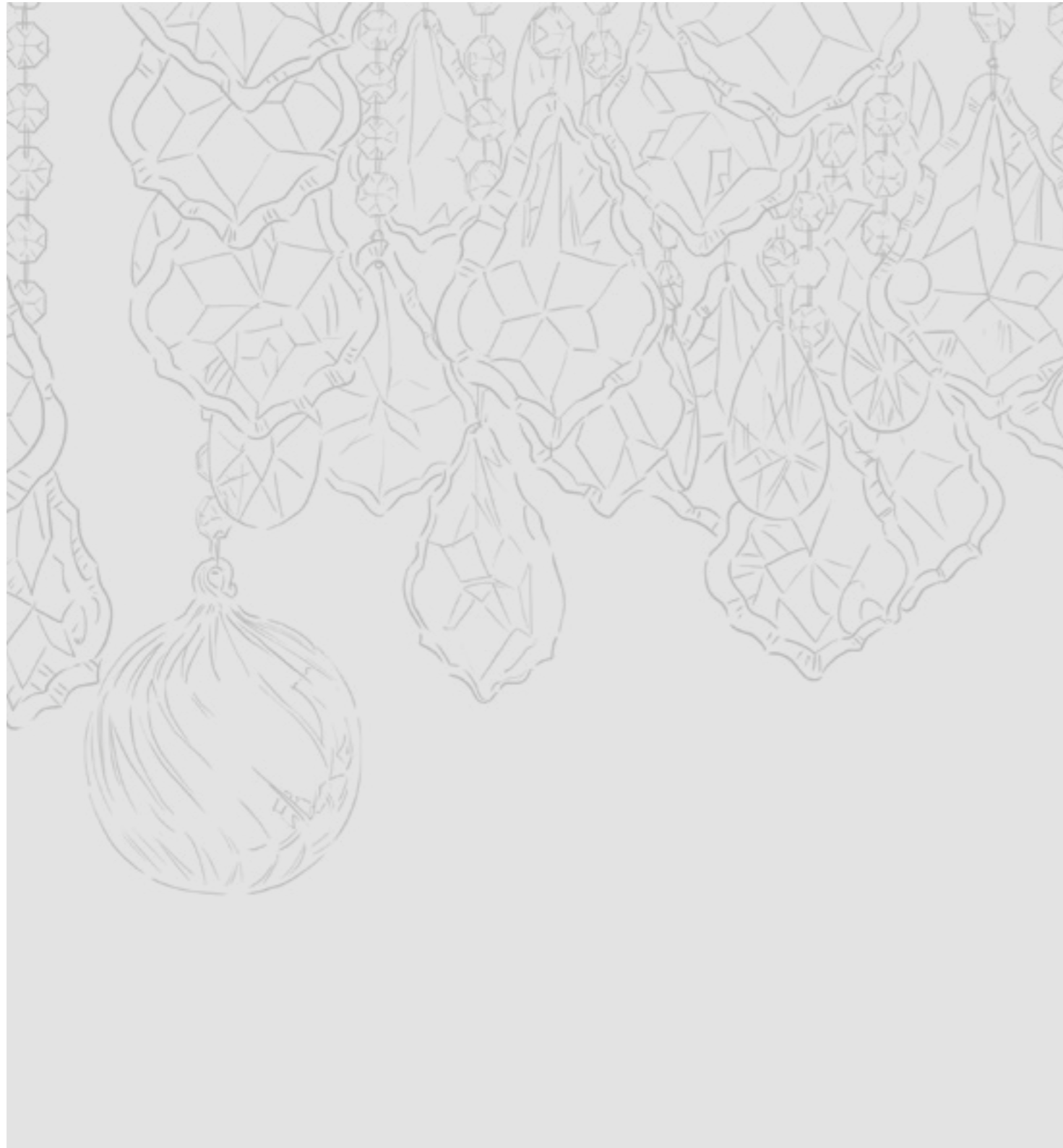

VE 901/70 CE 

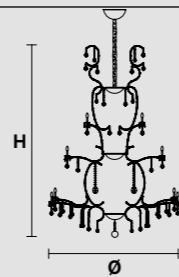

Ø 260 cm / 102.40"
 H 300 cm / 118.20"
 W 120 kg / 264.5 lb

WW 70×E14×40 W max (not included)
 USA 70×E12×40 W max (not included)

RW-DW 70×LED source -280 W tot



VE 901/70 DW



VE 907/35



VE 907/65

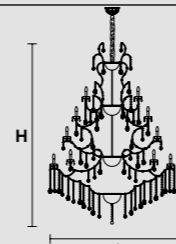
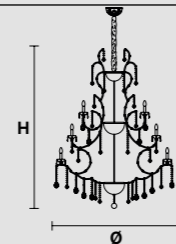

Ø 140 cm / 55.10"
 H 210 cm / 82.70"
 W 80 kg / 176.5 lb

WW 35×E14×40 W max (not included)
 USA 35×E12×40 W max (not included)

RW-DW 35×LED source -140 W tot

Ø 170 cm / 66.92"
 H 250 cm / 98.42"
 W 120 kg / 264.5 lb

WW 65×E14×40 W max (not included)
 USA 65×E12×40 W max (not included)

RW-DW 65×LED source -260 W tot

VE 907/65 RW



VE 909/15 CE VE 909/30 CE VE 909/60 CE

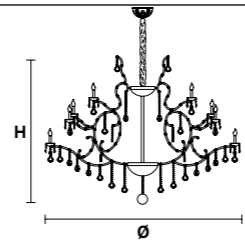
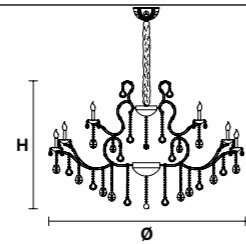
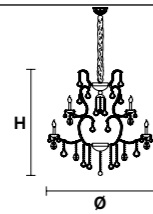

Ø 110 cm / 43.30"
H 110 cm / 43.30"
W 35 kg / 77.16 lb
WW 15×E14×40 W max (not included)
USA 15×E12×40 W max (not included)
RW-DW 15×LED source – 60 W tot

Ø 144 cm / 56.69"
H 102 cm / 40.15"
W 55 kg / 121.25 lb
WW 30×E14×40 W max (not included)
USA 30×E12×40 W max (not included)
RW-DW 30×LED source – 120 W tot

Ø 190 cm / 74.80"
H 145 cm / 57.80"
W 110 kg / 242.5 lb
WW 60×E14×40 W max (not included)
USA 60×E12×40 W max (not included)
RW-DW 60×LED source – 240 W tot

VE 909/30 DW

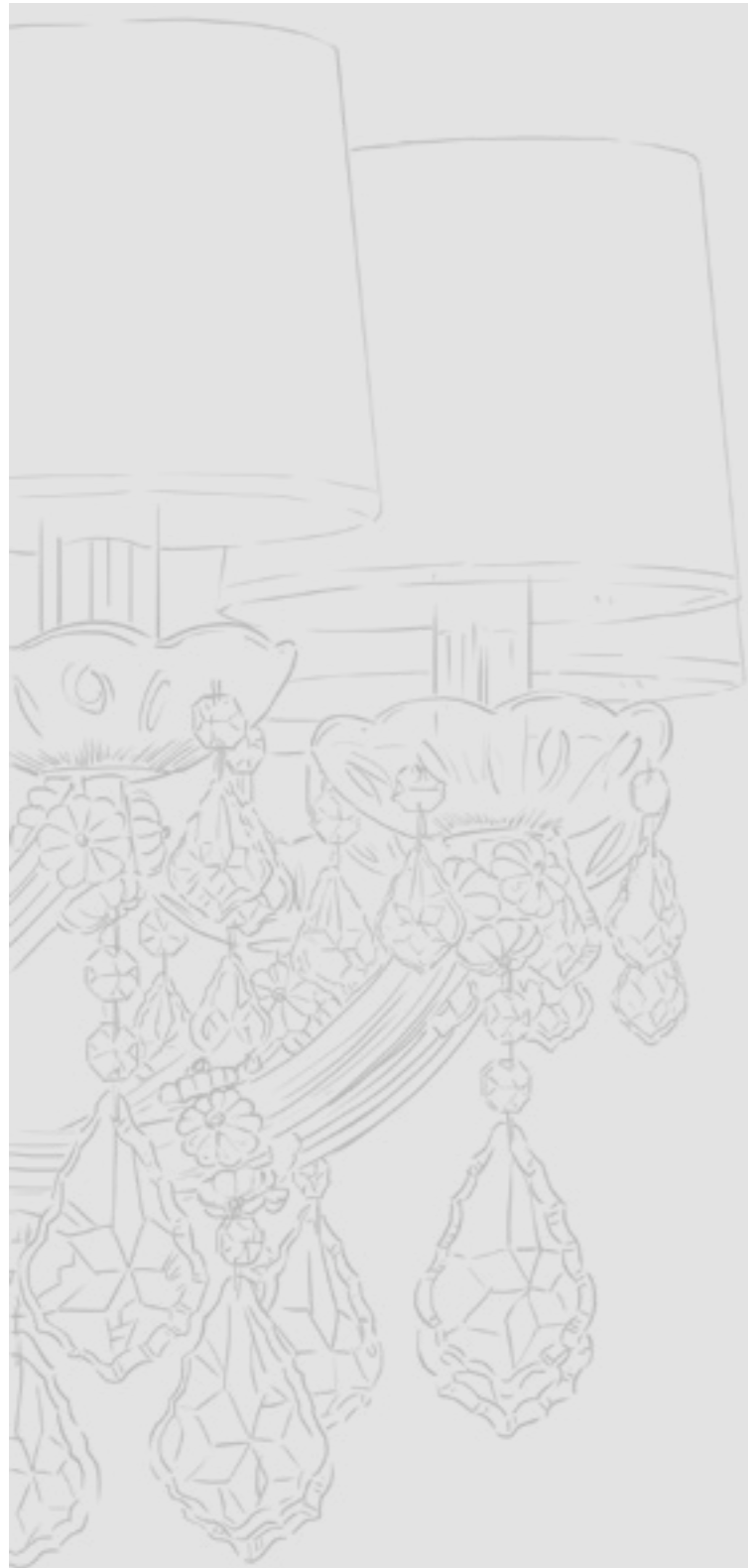

VE 913/12

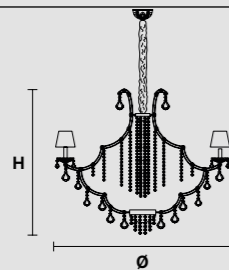

Ø 110 cm / 43.30"
H 95 cm / 37.40"
W 38 kg / 83.77 lb

WW 12×E14×40 W max (not included)
USA 12×E12×40 W max (not included)

RW-DW 12×LED source – 48 W tot

VE 913/36

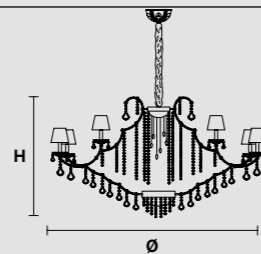

Ø 167 cm / 65.74"
H 98 cm / 38.58"
W 58 kg / 127.86 lb

WW 36×E14×40 W max (not included)
USA 36×E12×40 W max (not included)

RW-DW 36×LED source – 144 W

VE 913/46

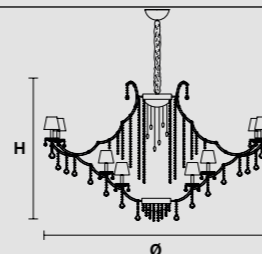

Ø 205 cm / 80.70"
H 120 cm / 47.24"
W 100 kg / 220.4 lb

WW 46×E14×40 W max (not included)
USA 46×E12×40 W max (not included)

RW-DW 46×LED source – 184 W

VE 913/36

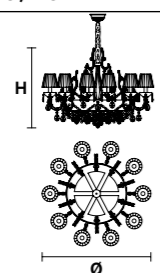
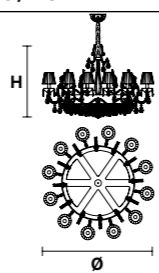
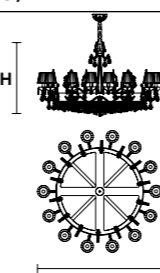

| VE 923/13 | VE 923/18 | VE 923/21 |
|---|--|---|
|  |  |  |
| <p>Ø 80 cm / 31.49"</p> <p>H 65 cm / 25.59"</p> <p>W 19 kg / 41.88 lb</p> <p>WW 10×E14×40 W max (not included) 3×E27×60 W max (not included)</p> <p>USA 10×E12×40 W max (not included) 3×E26×60 W max (not included)</p> <p>RW-DW 13×LED source -52 W tot</p> | <p>Ø 100 cm / 39.37"</p> <p>H 65 cm / 25.59"</p> <p>W 40 kg / 88.18 lb</p> <p>WW 12×E14×40 W max (not included) 6×E27×60 W max (not included)</p> <p>USA 12×E12×40 W max (not included) 6×E26×60 W max (not included)</p> <p>RW-DW 18×LED source -72 W tot</p> | <p>Ø 125 cm / 49.21"</p> <p>H 75 cm / 29.52"</p> <p>W 80 kg / 176.36 lb</p> <p>WW 14×E14×40 W max (not included) 7×E27×60 W max (not included)</p> <p>USA 14×E12×40 W max (not included) 7×E26×60 W max (not included)</p> <p>RW-DW 21×LED source -84 W tot</p> |

VE 923/13



VE 927/12 CE VE 927/16 CE VE 927/24 CE VE 927/30 CE

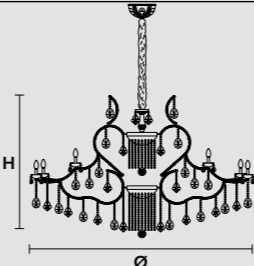
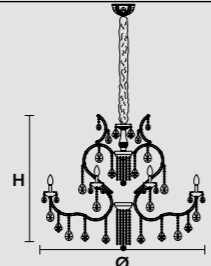
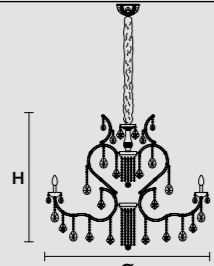
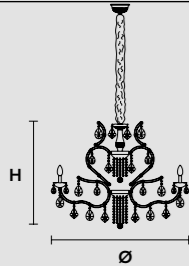

Ø 85 cm / 33.46"
H 70 cm / 27.55"
W 25 kg / 55.11 lb

Ø 118 cm / 46.45"
H 84 cm / 33.07"
W 33 kg / 72.75 lb

Ø 118 cm / 46.45"
H 84 cm / 33.07"
W 40 kg / 88.18 lb

Ø 165 cm / 64.96"
H 105 cm / 41.38"
W 82 kg / 180.77 lb

WW 12×E14×40 W max (not included)
USA 12×E12×40 W max (not included)
RW-DW 12×LED source - 48W tot

WW 16×E14×40 W max (not included)
USA 16×E12×40 W max (not included)
RW-DW 16×LED source - 64 W tot

WW 24×E14×40 W max (not included)
USA 24×E12×40 W max (not included)
RW-DW 24×LED source - 96 W tot

WW 30×E14×40 W max (not included)
USA 30×E12×40 W max (not included)
RW-DW 30×LED source - 120 W tot

VE 927/16



| VE 935/12 | VE 935/18 | VE 935/30 |
|--|---|---|
| | | |
| <p>Ø 75 cm / 29.52"</p> <p>H 60 cm / 23.62"</p> <p>W 20 kg / 44.09 lb</p> <p>WW 12×E14×40 W max (not included)</p> <p>USA 12×E12×40 W max (not included)</p> <p>RW-DW 12×LED source - 48 W tot</p> | <p>Ø 120 cm / 47.24"</p> <p>H 75 cm / 29.52"</p> <p>W 30 kg / 66.13 lb</p> <p>WW 18×E14×40 W max (not included)</p> <p>USA 18×E12×40 W max (not included)</p> <p>RW-DW 18×LED source - 72 W tot</p> | <p>Ø 170 cm / 66.92"</p> <p>H 85 cm / 33.46"</p> <p>W 50 kg / 110.23 lb</p> <p>WW 30×E14×40 W max (not included)</p> <p>USA 30×E12×40 W max (not included)</p> <p>RW-DW 30×LED source - 120 W tot</p> |

VE 935/30



VE 925/15 CE 

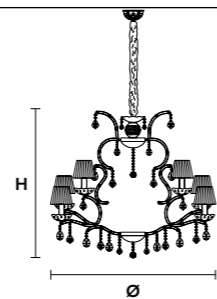

- Ø 100 cm / 39.37"
- H 80 cm / 31.49"
- W 24 kg / 52.91 lb
- WW 15×E14×40 W max (not included)
- USA 15×E12×40 W max (not included)
- RW-DW 15×LED source - 60 W tot

VE 925/15



VE 951/15 CE VE 951/24 CE VE 951/40 CE

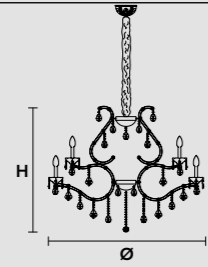

Ø 105 cm / 41.33"
 H 85 cm / 33.46"
 W 20 kg / 44.09 lb
 WW 15×E14×40 W max (not included)
 USA 15×E12×40 W max (not included)
 RW-DW 15×LED source -60 W tot

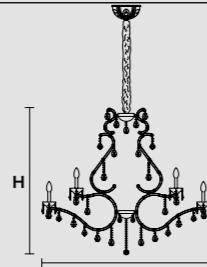

Ø 145 cm / 57.09"
 H 125 cm / 49.21"
 W 42.5 kg / 93.69 lb
 WW 24×E14×40 W max (not included)
 USA 24×E12×40 W max (not included)
 RW-DW 24×LED source -96 W tot

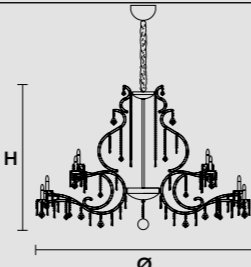

Ø 200 cm / 78.74"
 H 135 cm / 53.14"
 W 80 kg / 176.36 lb
 WW 40×E14×40 W max (not included)
 USA 40×E12×40 W max (not included)
 RW-DW 40×LED source -160 W tot

VE 951/24 RW

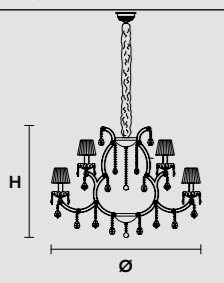
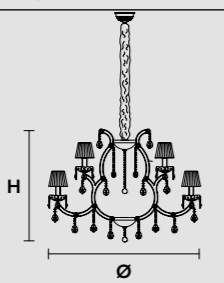
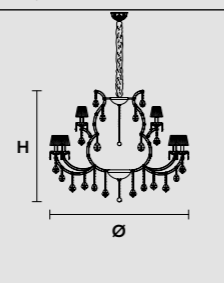
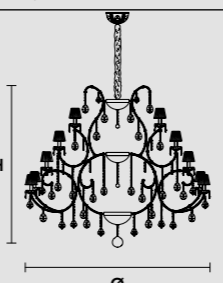

| VE 933/12 | VE 933/15 | VE 933/24 | VE 933/50 |
|--|--|--|---|
|  |  |  |  |
| <p>Ø 80 cm / 31.49"</p> <p>H 65 cm / 25.59"</p> <p>W 20 kg / 44.09 lb</p> <p>WW 12×E14×40 W max (not included)</p> <p>USA 12×E12×40 W max (not included)</p> <p>RW-DW 12×LED source – 48 W tot</p> | <p>Ø 80 cm / 31.49"</p> <p>H 65 cm / 25.59"</p> <p>W 20 kg / 44.09 lb</p> <p>WW 15×E14×40 W max (not included)</p> <p>USA 15×E12×40 W max (not included)</p> <p>RW-DW 15×LED source – 40 W tot</p> | <p>Ø 120 cm / 47.24"</p> <p>H 110 cm / 43.30"</p> <p>W 45 kg / 99.20 lb</p> <p>WW 24×E14×40 W max (not included)</p> <p>USA 24×E12×40 W max (not included)</p> <p>RW-DW 24×LED source – 96 W tot</p> | <p>Ø 160 cm / 62.99"</p> <p>H 155 cm / 61.02"</p> <p>W 83 kg / 182.98 lb</p> <p>WW 50×E14×40 W max (not included)</p> <p>USA 50×E12×40 W max (not included)</p> <p>RW-DW 50×LED source – 200W tot</p> |

VE 933/50

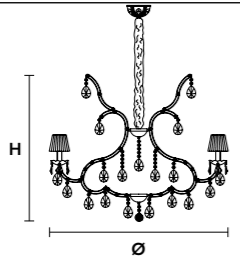
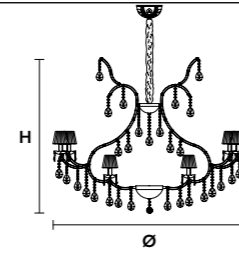
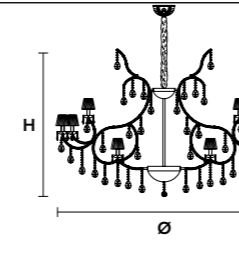

| VE 959/12 | VE 959/30 | VE 959/56 |
|---|--|--|
|  |  |  |
| <p>Ø 115 cm / 45.27"</p> <p>H 95 cm / 37.40"</p> <p>W 30 kg / 66.13 lb</p> <p>WW 12×E14×40 W max (not included)</p> <p>USA 12×E12×40 W max (not included)</p> <p>RW-DW 12×LED source – 48 W tot</p> | <p>Ø 155 cm / 61.02"</p> <p>H 125 cm / 49.21"</p> <p>W 48 kg / 105.82 lb</p> <p>WW 30×E14×40 W max (not included)</p> <p>USA 30×E12×40 W max (not included)</p> <p>RW-DW 30×LED source – 120 W</p> | <p>Ø 200 cm / 78.74"</p> <p>H 140 cm / 55.11"</p> <p>W 84 kg / 185.18 lb</p> <p>WW 56×E14×40 W max (not included)</p> <p>USA 56×E12×40 W max (not included)</p> <p>RW-DW 56×LED source – 224 W</p> |

VE 959/12 CG



| | | |
|--|---|---|
| <p>VE 989/15 </p> | <p>VE 989/24 </p> | <p>VE 989/36 </p> |
| <p>Ø 95 cm / 37.40" H 55 cm / 21.63" W 17 kg / 37.47 lb</p> <p>WW 15×E14×40 W max (not included) USA 15×E12×40 W max (not included)</p> <p>RW-DW 15×LED source – 60 W tot</p> | <p>Ø 140 cm / 55.11" H 80 cm / 31.49" W 30 kg / 66.13 lb</p> <p>WW 24×E14×40 W max (not included) USA 24×E12×40 W max (not included)</p> <p>RW-DW 24×LED source – 96 W tot</p> | <p>Ø 165 cm / 64.96" H 90 cm / 35.43" W 48 kg / 105.82 lb</p> <p>WW 40×E14×40 W max (not included) USA 40×E12×40 W max (not included)</p> <p>RW-DW 36×LED source – 144 W</p> |

VE 989/15 DW

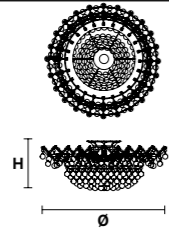
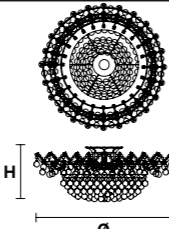
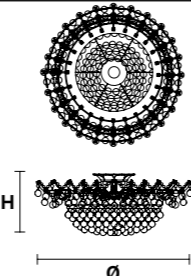

| VE 919/PL10 | CE | VE 919/PL12 | CE | VE 919/PL20 | CE |
|---|----|---|----|---|----|
|  | |  | |  | |
| Ø 90 cm / 35.43" | | Ø 105 cm / 41.33" | | Ø 130 cm / 51.18" | |
| H 35 cm / 13.77" | | H 35 cm / 13.77" | | H 45 cm / 17.71" | |
| W 34 kg / 74.95 lb | | W 44 kg / 97 lb | | W 80 kg / 176.36 lb | |
| WW 10×E14×40 W max (not included) USA 10×E12×40 W max (not included) | | WW 12×E14×40 W max (not included) USA 12×E12×40 W max (not included) | | WW 20×E14×40 W max (not included) USA 20×E12×40 W max (not included) | |
| RW-DW 10×LED source -40 W tot | | RW-DW 12×LED source -48 W tot | | RW-DW 20×LED source -80 W tot | |

VE 919/PL12

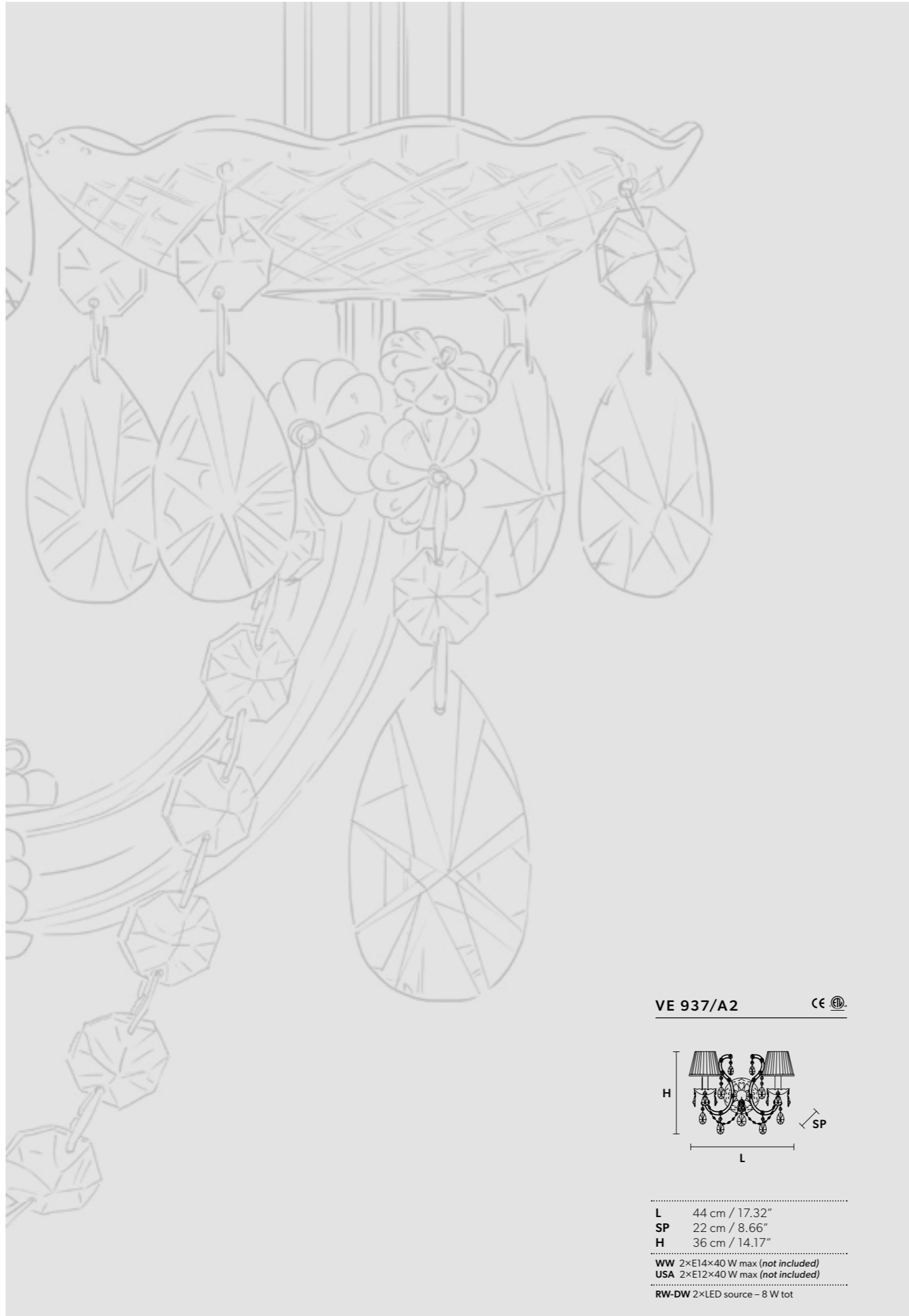



VE 921/A3+1

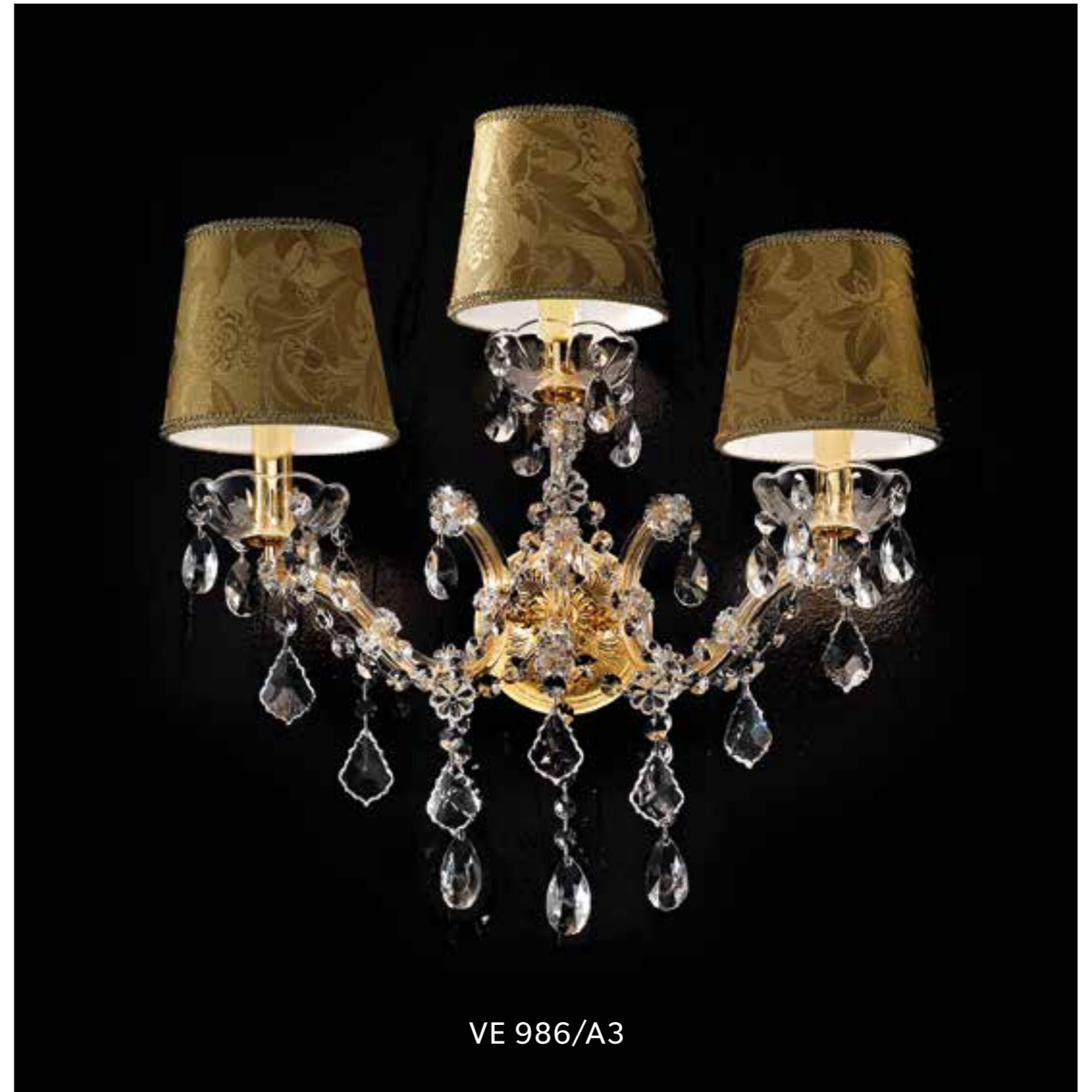

VE 986/A3

VE 921/A3+1 

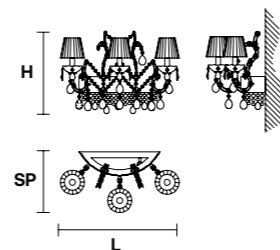

L 60 cm / 23.62"
 SP 30 cm / 11.81"
 H 40 cm / 15.75"
 WW 4×E14×40 W max (not included)
 USA 4×E12×40 W max (not included)
 RW-DW 4×LED source - 16 W tot

VE 986/A3 

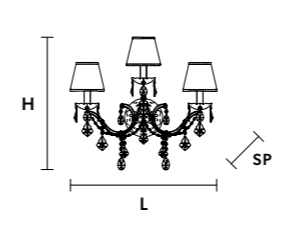

L 50 cm / 19.69"
 SP 25 cm / 9.84"
 H 55 cm / 21.64"
 WW 3×E14×40 W max (not included)
 USA 3×E12×40 W max (not included)
 RW-DW 3×LED source - 12 W tot

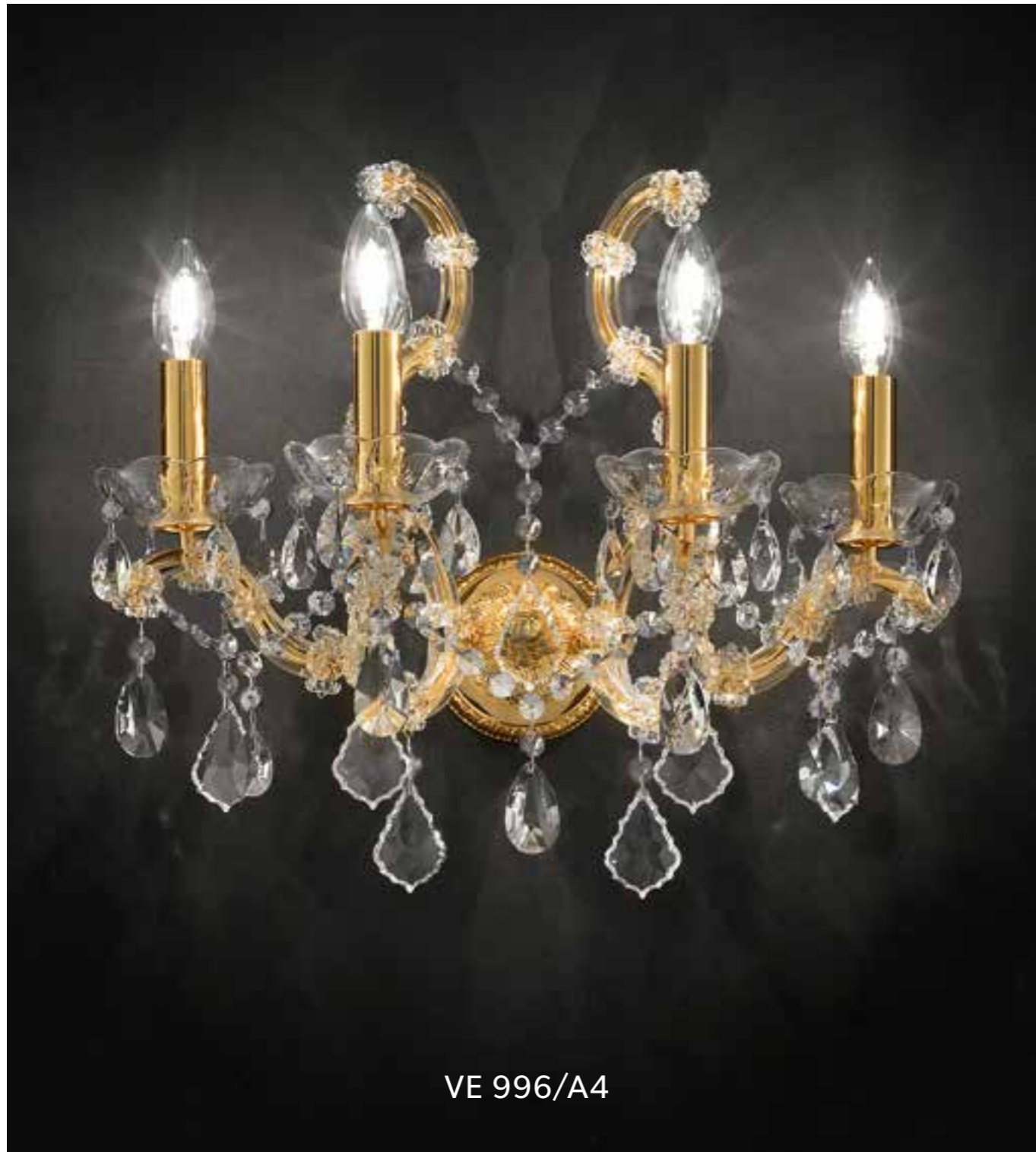

VE 996/A4

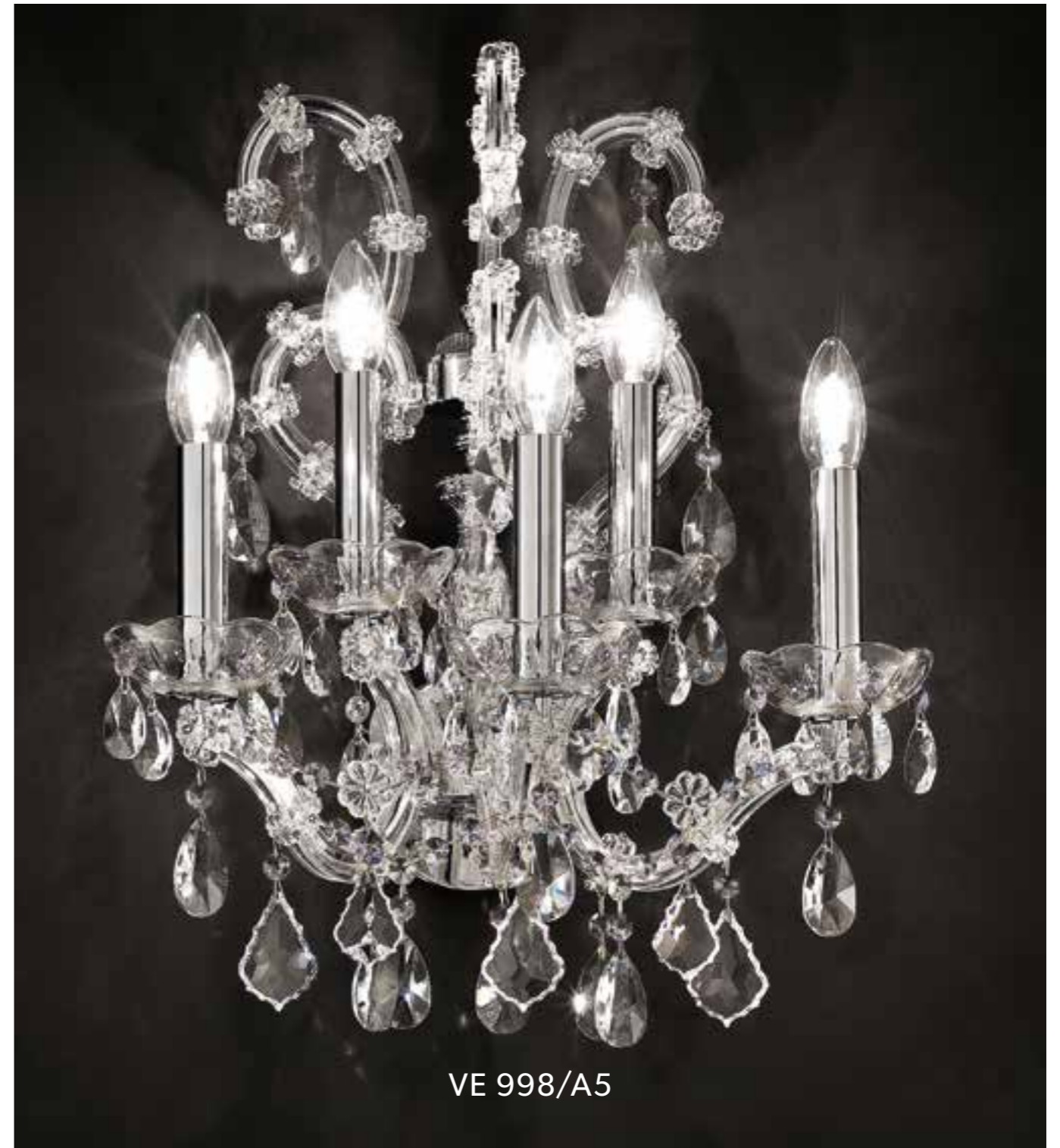

VE 998/A5

VE 996/A4 

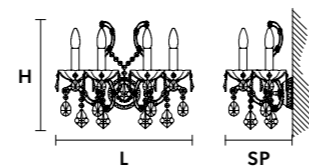

L 48 cm / 18.90"
 SP 27 cm / 10.63"
 H 41 cm / 16.14"

WW 4×E14×40 W max (not included)
 USA 4×E12×40 W max (not included)

RW-DW 4×LED source -16 W tot

VE 998/A5 

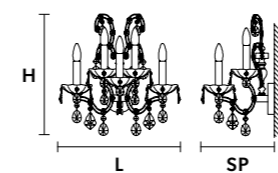

L 42 cm / 16.54"
 SP 32 cm / 12.60"
 H 53 cm / 20.87"

WW 5×E14×40 W max (not included)
 USA 5×E12×40 W max (not included)

RW-DW 5×LED source - 20 W tot

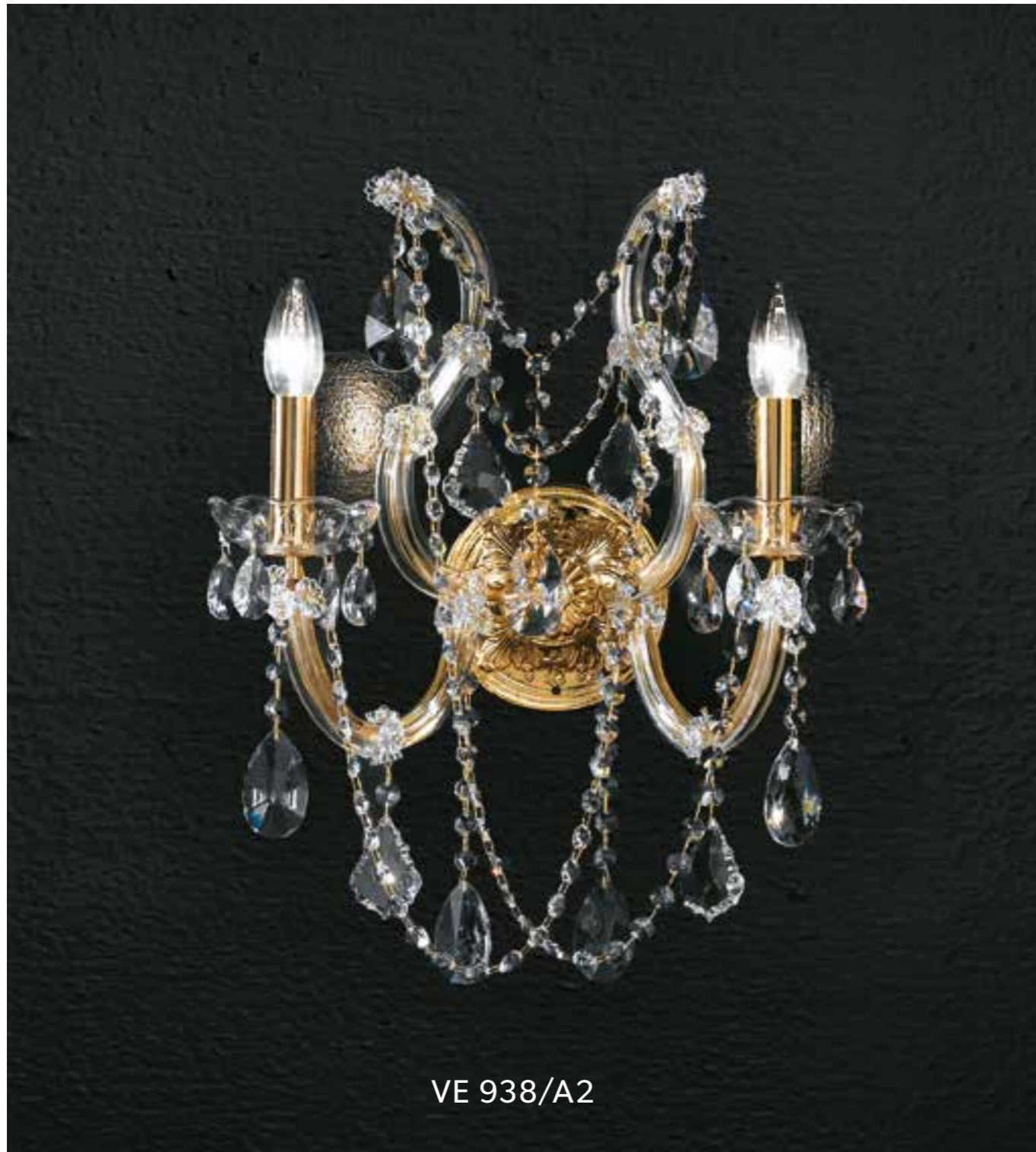

VE 938/A2



VE 938/TL5

VE 938/STL5

VE 938/A1 CE VE 938/A2 CE VE 938/STL5 CE VE 938/TL5 CE

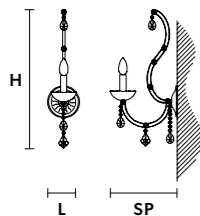

L 15 cm / 5.91"
SP 22 cm / 8.66"
H 40 cm / 15.75"
WW 1x E14x40 W max (not included)
USA 1x E12x40 W max (not included)
RW-DW 1x LED source - 4 W tot

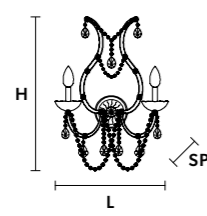

L 30 cm / 11.81"
SP 22 cm / 8.66"
H 50 cm / 19.69"
WW 2x E14x40 W max (not included)
USA 2x E12x40 W max (not included)
RW-DW 2x LED source - 8 W tot

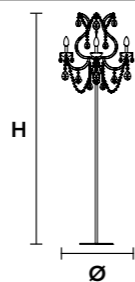

Ø 50 cm / 19.69"
H 185 cm / 72.83"
WW 5x E14x40 W max (not included)
USA 5x E12x40 W max (not included)
RW-DW 5x LED source - 20 W tot

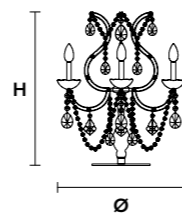

Ø 50 cm / 19.69"
H 65 cm / 25.59"
WW 5x E14x40 W max (not included)
USA 5x E12x40 W max (not included)
RW-DW 5x LED source - 20 W tot



VE 940/A5

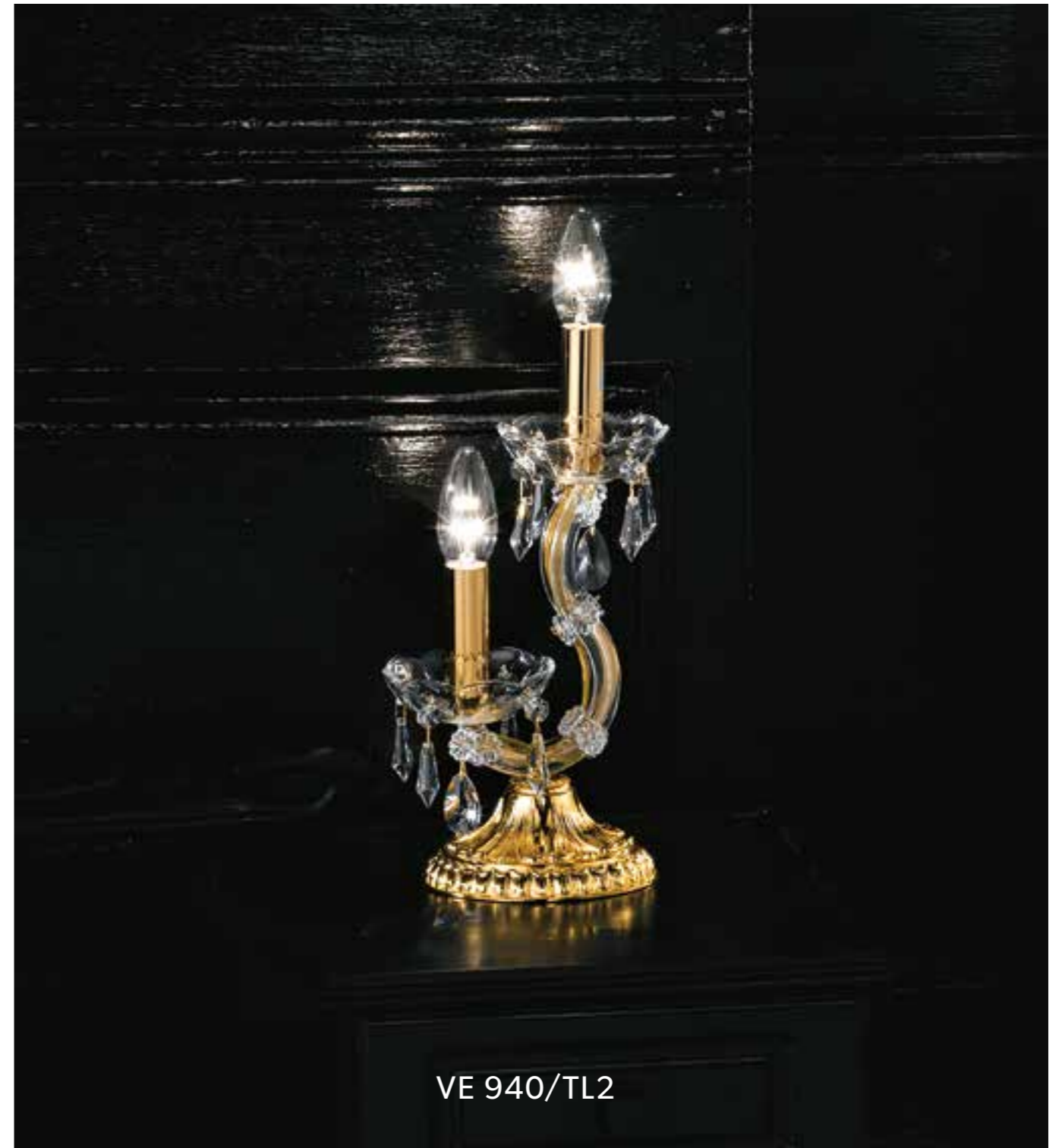

VE 940/TL2

VE 940/A5 VE 940/TL1 VE 940/TL2

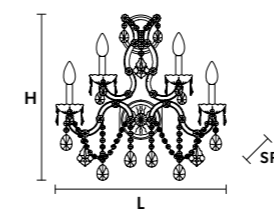

L 35 cm / 13.77"
 SP 35 cm / 13.77"
 H 50 cm / 19.68"

WW 5x E14x40 W max (not included)
 USA 5x E12x40 W max (not included)
 RW-DW 5x LED source -20 W tot

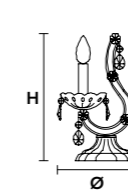

Ø 20 cm / 7.87"
 H 25 cm / 9.84"

WW 1x E14x40 W max (not included)
 USA 1x E12x40 W max (not included)
 RW-DW 1x LED source -4 W tot

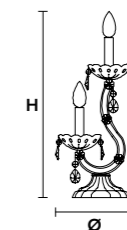

Ø 20 cm / 7.87"
 H 35 cm / 13.78"

WW 2x E14x40 W max (not included)
 USA 2x E12x40 W max (not included)
 RW-DW 2x LED source -8 W tot

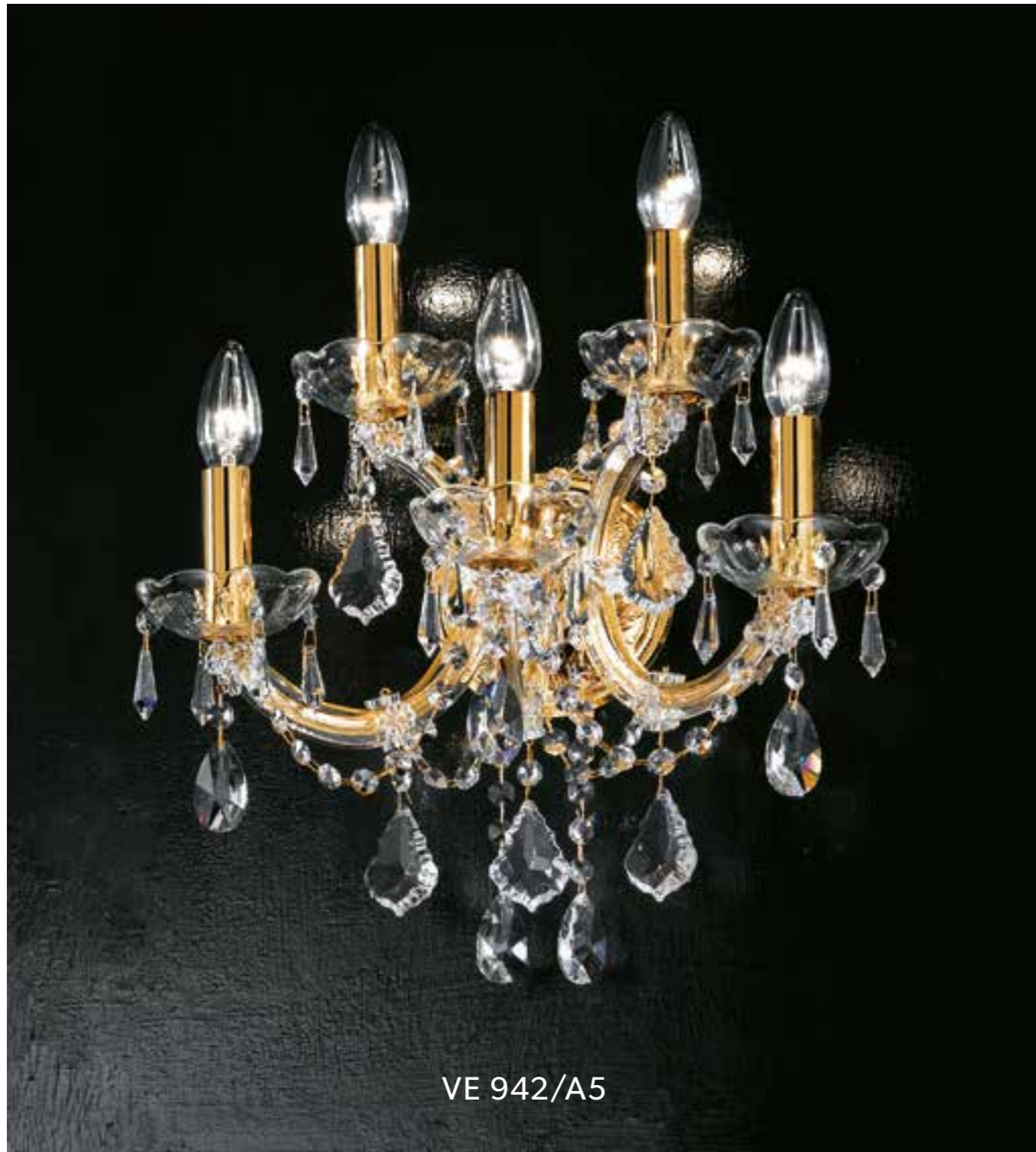

VE 942/A5



VE 942/STL5

VE 942/A5

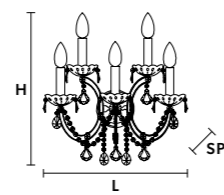

L 45 cm / 17.72"
 SP 25 cm / 9.84"
 H 40 cm / 15.75"

WW 5×E14×40 W max (not included)
 USA 5×E12×40 W max (not included)

RW-DW 5×LED source – 20 W tot

VE 942/STL5

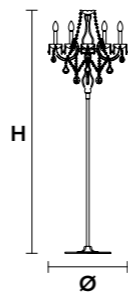

Ø 55 cm / 21.65"
 H 185 cm / 72.83"

WW 5×E14×40 W max (not included)
 USA 5×E12×40 W max (not included)

RW-DW 5×LED source – 20 W tot

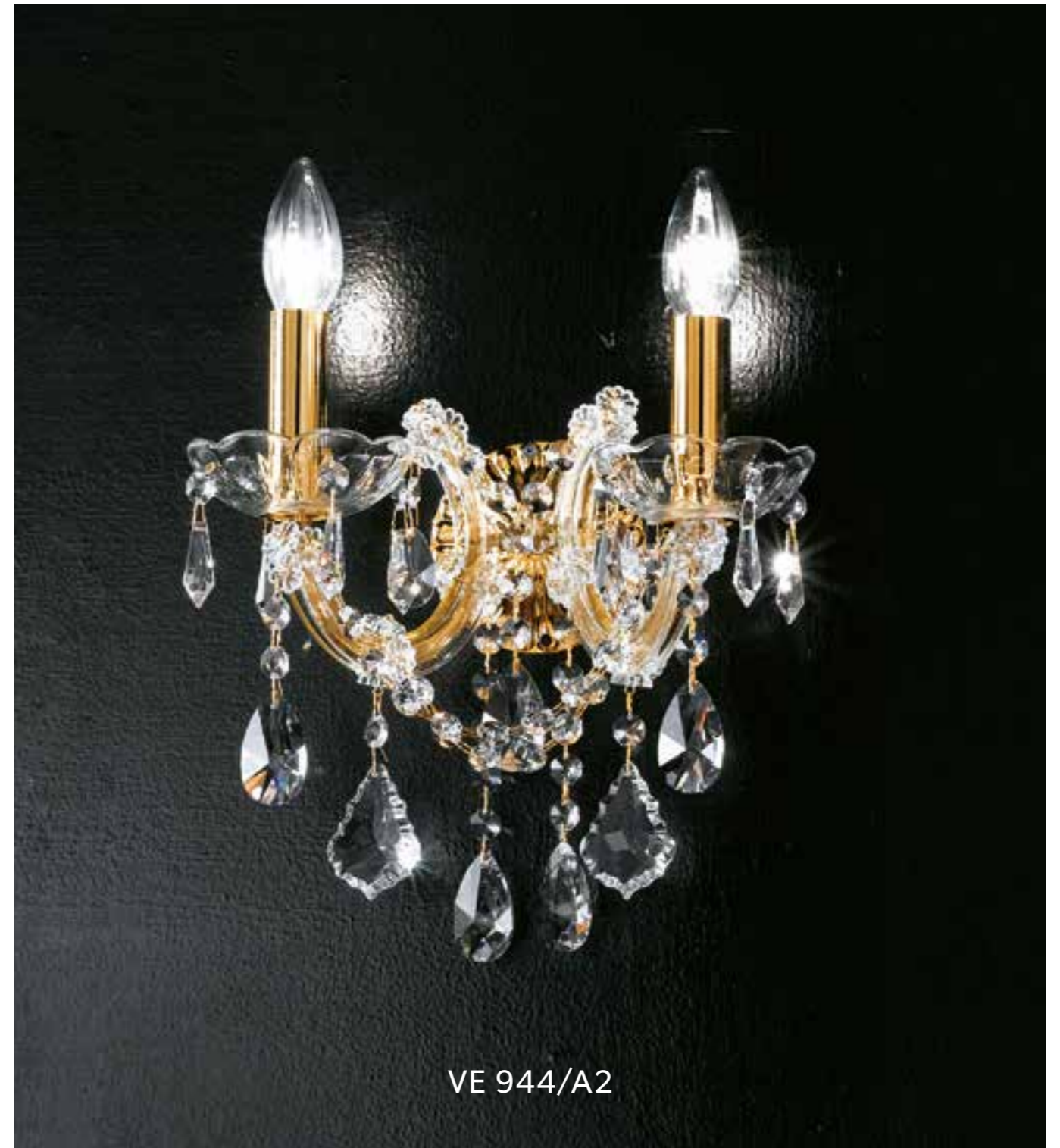



VE 944/TL3

VE 944/TL2

VE 944/A2

VE 944/TL1 

VE 944/TL2 

VE 944/TL3 

VE 944/A1 

VE 944/A2 

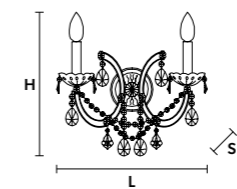
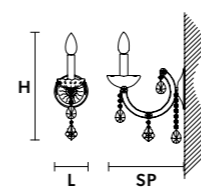
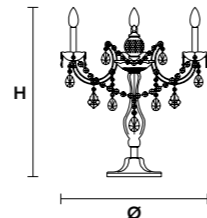
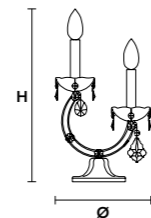
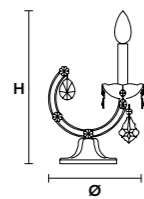

Ø 20 cm / 7.87"
H 28 cm / 11.02"

Ø 20 cm / 7.87"
H 35 cm / 13.78"

Ø 45 cm / 17.72"
H 60 cm / 23.62"

L 12 cm / 4.72"
SP 20 cm / 7.87"
H 28 cm / 11.02"

L 28 cm / 11.02"
SP 20 cm / 7.87"
H 28 cm / 11.02"

WW 1×E14×40 W max (not included)
USA 1×E12×40 W max (not included)
RW-DW 1×LED source -4 W tot

WW 2×E14×40 W max (not included)
USA 2×E12×40 W max (not included)
RW-DW 2×LED source -8 W tot

WW 3×E14×40 W max (not included)
USA 3×E12×40 W max (not included)
RW-DW 3×LED source -12 W tot

WW 1×E14×40 W max (not included)
USA 1×E12×40 W max (not included)
RW-DW 1×LED source -4 W tot

WW 2×E14×40 W max (not included)
USA 2×E12×40 W max (not included)
RW-DW 2×LED source -8 W tot

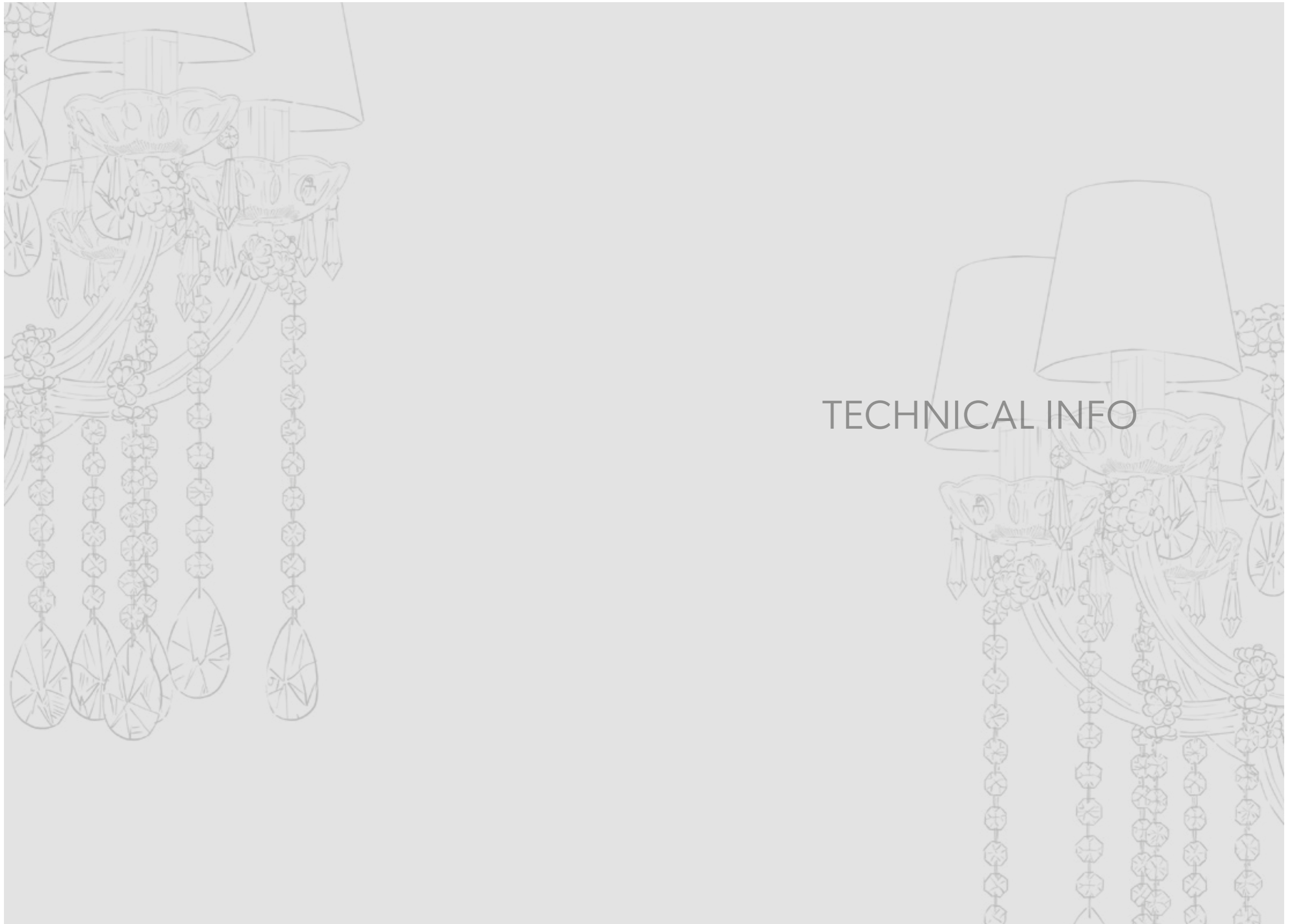

TECHNICAL INFO

FINITURE / FINISHING

Bagno galvanico / Galvanic Bath



G03 Oro lucido
Shiny gold

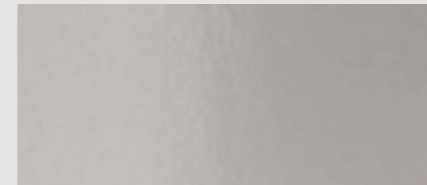

G04 Cromo lucido
Shiny chrome

Verniciati / Painted



V31 Rosso lucido
Shiny red



V42 Melanzana lucido
Shiny aubergine



V23 Arancio lucido
Shiny orange



V41 Lilla lucido
Shiny lilac

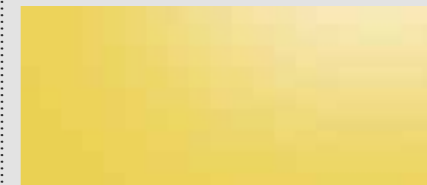

V22 Giallo lucido
Shiny yellow



V53 Blu lucido
Shiny blue

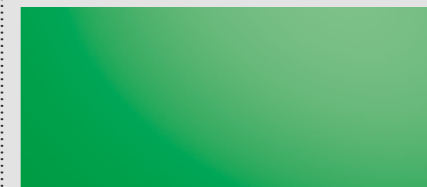

V63 Verde lucido
Shiny green

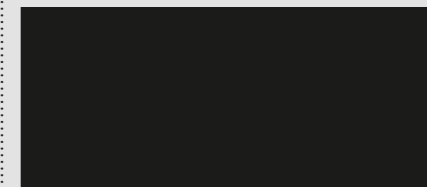

V9L Nero lucido
Shiny black

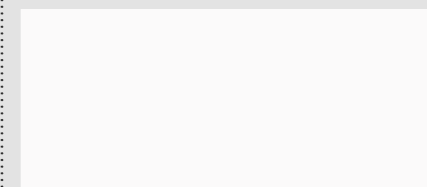

V92 Bianco lucido
Shiny white

Verificare la disponibilità di ciascuna finitura per specifici articoli / Availability of each finish to be confirmed for specific items.

Indice/Index

| ART. | LIGHTS | Ø/L-SP | H | PAG. |
|--------|--------|--------------|--------|------|
| VE 901 | 70 | 260 cm | 300 cm | 97 |
| VE 903 | 15 | 90 cm | 70 cm | 94 |
| | 24 | 150 cm | 120 cm | 94 |
| | 56 | 210 cm | 180 cm | 95 |
| VE 905 | 15 | 90 cm | 80 cm | 46 |
| | 24 | 145 cm | 120 cm | 46 |
| | 56 | 210 cm | 195 cm | 47 |
| VE 906 | 15 | 100 cm | 78 cm | 44 |
| | 32 | 125 cm | 90 cm | 44 |
| | 42 | 150 cm | 180 cm | 44 |
| | 49 | 190 cm | 170 cm | 45 |
| VE 907 | 35 | 140 cm | 210 cm | 98 |
| | 65 | 170 cm | 250 cm | 99 |
| VE 909 | 15 | 110 cm | 110 cm | 100 |
| | 30 | 144 cm | 102 cm | 101 |
| | 60 | 190 cm | 145 cm | 100 |
| VE 910 | 25 | 100 cm | 75 cm | 52 |
| | 32 | 125 cm | 90 cm | 52 |
| | 42 | 150 cm | 180 cm | 52 |
| | 49 | 185 cm | 165 cm | 52 |
| | 56 | 185 cm | 165 cm | 53 |
| VE 911 | 25 | 100 cm | 160 cm | 62 |
| | 32 | 125 cm | 170 cm | 62 |
| | 45 | 150 cm | 270 cm | 62 |
| | 56 | 185 cm | 240 cm | 63 |
| | 110 | 250 cm | 400 cm | 61 |
| VE 913 | 12 | 110 cm | 95 cm | 102 |
| | 36 | 167 cm | 98 cm | 103 |
| | 46 | 205 cm | 120 cm | 102 |
| VE 915 | 12 | 95 cm | 82 cm | 69 |
| | 36 | 170 cm | 90 cm | 68 |
| | 48 | 205 cm | 140 cm | 68 |
| VE 917 | 15 | 85 cm | 60 cm | 83 |
| VE 918 | 30 | 100 cm | 90 cm | 75 |
| | 48 | 165 cm | 110 cm | 74 |
| | 72 | 200 cm | 160 cm | 74 |
| VE 919 | PL10 | 90 cm | 35 cm | 120 |
| | PL12 | 105 cm | 35 cm | 121 |
| | PL20 | 130 cm | 45 cm | 120 |
| VE 920 | 14 | 90 x 45 cm | 50 cm | 64 |
| | 24 | 160 x 70 cm | 60 cm | 65 |
| | 30 | 200 x 70 cm | 60 cm | 64 |
| VE 921 | 24 | 150 x 85 cm | 68 cm | 31 |
| | 32 | 200 x 110 cm | 65 cm | 30 |
| | A3+1 | 60 x 30 cm | 40 cm | 124 |
| VE 923 | 13 | 80 cm | 65 cm | 105 |
| | 18 | 100 cm | 65 cm | 104 |
| | 21 | 125 cm | 75 cm | 104 |
| VE 925 | 15 | 100 cm | 80 cm | 111 |
| VE 927 | 12 | 85 cm | 70 cm | 106 |
| | 16 | 118 cm | 84 cm | 107 |
| | 24 | 118 cm | 84 cm | 106 |
| | 30 | 165 cm | 105 cm | 106 |
| VE 929 | 24 | 120 cm | 120 cm | 55 |
| | 36 | 165 cm | 160 cm | 54 |
| VE 931 | 12 | 100 cm | 46 cm | 77 |
| VE 933 | 12 | 80 cm | 65 cm | 114 |
| | 15 | 80 cm | 65 cm | 114 |
| | 24 | 120 cm | 110 cm | 114 |
| | 50 | 160 cm | 155 cm | 115 |
| VE 934 | 12 | 95 cm | 80 cm | 78 |
| | 40 | 150 cm | 95 cm | 79 |
| VE 935 | 12 | 75 cm | 60 cm | 108 |
| | 18 | 120 cm | 75 cm | 108 |
| | 30 | 170 cm | 85 cm | 109 |
| VE 937 | A2 | 44 x 22 cm | 36 cm | 123 |
| VE 938 | A1 | 15 x 22 cm | 40 cm | 128 |
| | A2 | 30 x 22 cm | 50 cm | 128 |
| | STL5 | 50 cm | 185 cm | 129 |
| | TL5 | 50 cm | 65 cm | 129 |

| ART. | LIGHTS | Ø/L-SP | H | PAG. |
|--------|--------|--------------|--------|------|
| VE 940 | 5 | 60 cm | 50 cm | 91 |
| | 8 | 62 cm | 50 cm | 90 |
| | 12 | 62 cm | 57 cm | 90 |
| | 18 | 105 cm | 85 cm | 90 |
| | 24 | 100 cm | 70 cm | 90 |
| | A5 | 35 x 35 cm | 50 cm | 130 |
| | TL1 | 20 cm | 25 cm | 131 |
| | TL2 | 20 cm | 35 cm | 131 |
| VE 942 | A5 | 45 x 25 cm | 40 cm | 132 |
| | STL5 | 55 cm | 185 cm | 133 |
| VE 944 | 3 | 47 cm | 42 cm | 92 |
| | 5 | 47 cm | 42 cm | 93 |
| | A1 | 12 x 20 cm | 28 cm | 135 |
| | A2 | 28 x 20 cm | 28 cm | 135 |
| | TL1 | 20 cm | 28 cm | 134 |
| | TL2 | 20 cm | 35 cm | 134 |
| | TL3 | 45 cm | 60 cm | 134 |
| VE 945 | 18 | 107 x 65 cm | 50 cm | 24 |
| | 20 | 153 x 93 cm | 66 cm | 24 |
| | 24 | 129 x 88 cm | 69 cm | 24 |
| | 32 | 200 x 88 cm | 80 cm | 25 |
| | 46 | 192 x 114 cm | 110 cm | 24 |
| VE 950 | 18 | 105 cm | 65 cm | 81 |
| VE 951 | 15 | 105 cm | 85 cm | 112 |
| | 24 | 145 cm | 125 cm | 113 |
| | 40 | 200 cm | 135 cm | 112 |
| VE 954 | 1 | 40 cm | 50 cm | 89 |
| VE 956 | 1 | 40 cm | 40 cm | 87 |
| VE 959 | 12 | 115 cm | 95 cm | 117 |
| | 30 | 155 cm | 125 cm | 116 |
| | 56 | 200 cm | 140 cm | 116 |
| VE 961 | 8 | 75 cm | 42 cm | 29 |
| | 10 | 85 cm | 42 cm | 28 |
| | 12 | 75 cm | 60 cm | 28 |
| | 15 | 85 cm | 60 cm | 28 |
| | 24 | 150 cm | 105 cm | 28 |
| VE 973 | 70 | 290 cm | 300 cm | 51 |
| VE 975 | 16 | 110 cm | 70 cm | 85 |
| VE 980 | 12 | 106 cm | 70 cm | 66 |
| | 24 | 140 cm | 70 cm | 67 |
| | 60 | 220 cm | 75 cm | 66 |
| VE 981 | 12 | 106 cm | 70 cm | 57 |
| | 24 | 140 cm | 70 cm | 59 |
| | 60 | 220 cm | 75 cm | 58 |
| VE 984 | 12 | 106 cm | 70 cm | 72 |
| | 24 | 140 cm | 70 cm | 72 |
| | 60 | 220 cm | 75 cm | 73 |
| VE 986 | 15 | 95 cm | 70 cm | 40 |
| | 18 | 135 cm | 90 cm | 41 |
| | 39 | 190 cm | 125 cm | 40 |
| | A3 | 50 x 25 cm | 55 cm | 125 |
| VE 987 | 15 | 95 cm | 130 cm | 42 |
| | 18 | 140 cm | 200 cm | 43 |
| | 39 | 190 cm | 210 cm | 42 |
| VE 988 | 32 | 130 cm | 90 cm | 70 |
| | 48 | 130 cm | 90 cm | 71 |
| VE 989 | 15 | 95 cm | 55 cm | 119 |
| | 24 | 140 cm | 80 cm | 118 |
| | 36 | 165 cm | 90 cm | 118 |
| VE 991 | 15 | 95 cm | 65 cm | 48 |
| | 24 | 140 cm | 100 cm | 49 |
| | 36 | 165 cm | 95 cm | 48 |
| VE 992 | 18 | 85 cm | 100 cm | 35 |
| | 30 | 115 cm | 140 cm | 37 |
| | 48 | 120 cm | 240 cm | 39 |
| | 70 | 150 cm | 380 cm | 38 |
| VE 996 | 15 | 95 cm | 60 cm | 26 |
| | 36 | 165 cm | 95 cm | 27 |
| | 48 | 210 cm | 110 cm | 26 |
| | A4 | 48 x 27 cm | 41 cm | 126 |
| VE 998 | 18 | 125 cm | 130 cm | 33 |
| | 40 | 170 cm | 120 cm | 32 |
| | 56 | 215 cm | 120 cm | 32 |
| | A5 | 42 x 32 cm | 53 cm | 127 |

CE

Attesta la conformità del prodotto alle disposizioni delle Direttive comunitarie.

It certifies the conformity of the products to the European Community provisions.

Il atteste la conformité du produit aux dispositions des directives communitaires.

Konformität des Produktes mit den Richtlinien der europäischen Gemeinschaft.

НАСТОЯЩИМ ПОДТВЕРЖДАЕТСЯ СООТВЕТСТВИЕ ПРОДУКЦИИ ПОЛОЖЕНИЯМ ДИРЕКТИВ ЕС.

Certifica la conformidad del producto según las disposiciones de las directivas comunitarias.

CE标记是指产品的制造商证明该产品符合适用的EC指令的所有基本要求。

يُشهد بمطابقة المنتج لأحكام توجيهات المجتمع الأوروبي.



Il logo "ETL" si riferisce agli articoli che possono essere modificati con componenti certificati ETL. L'elenco degli articoli ETL si riferisce a prodotti testati e valutati in base agli standard di sicurezza del mercato statunitense. Per il mercato USA fare riferimento al listino dedicato.

"ETL" logos refers to articles which can be modified with ETL-compliance components. The "ETL" listing articles stands for tested and evaluated product to recognised US safety standards. For the US market, refer to the relevant price list.

"ETL" logo se réfère aux articles qui peuvent être modifiés par des composants certifiés ETL. la liste des articles ETL se réfère à des produits testés et évalués selon les normes de sécurité du marché américain. Pour le marché américain se référer à la liste des prix.

Das "ETL"-Logo bezieht sich auf Artikel, die mit ETL-zertifizierten Komponenten modifiziert werden können. Die Liste der ETL-Artikel bezieht sich auf Produkte, die nach den Sicherheitsstandards des US-Marktes getestet und bewertet wurden. Für den US-Markt beachten Sie bitte die entsprechende Preisliste.

ЛОГОТИП «ETL» ОТНОСИТСЯ К ЭЛЕМЕНТАМ, КОТОРЫЕ МОГУТ БЫТЬ МОДИФИЦИРОВАНЫ С ПОМОЩЬЮ СЕРТИФИЦИРОВАННЫХ ETL КОМПОНЕНТОВ. СПИСОК ЭЛЕМЕНТОВ ETL ОТНОСИТСЯ К ПРОДУКЦИИ, ПРОТЕСТИРОВАННОЙ И ОЦЕНЕННОЙ В СООТВЕТСТВИИ С ПРИЗНАННЫМИ СТАНДАРТАМИ БЕЗОПАСНОСТИ США. ДЛЯ ПОТРЕБИТЕЛЕЙ НАХОДЯЩИХСЯ В США СМ. СООТВЕТСТВУЮЩИЙ ПРАЙС-ЛИСТ.

El logo "ETL" indica los artículos, que pueden modificarse con componentes certificados ETL. La lista de los artículos ETL se refiere a los productos sometidos a prueba y evaluados en función de los estándares de seguridad del mercado estadounidense. Consultar la lista de precios específica para el mercado de los Estados Unidos.

"ETL" 徽标是指可以使用ETL认证的组件进行修改的项目。 ETL项目列表是指根据美国市场的安全标准进行测试和评估的产品。 对于美国市场, 请参考美国市场价格表。

يشير شعار «ETL» إلى المنتجات التي يمكن تعديلها باستخدام مكونات مُعتمدة من ETL. تشير قائمة منتجات ETL إلى المنتجات التي تم اختبارها وتقييمها وفقًا لمعايير السلامة في السوق الأمريكي. بالنسبة لسوق الولايات المتحدة الأمريكية، يُرجى الرجوع إلى قائمة الأسعار المُخصصة.

Im

Flusso luminoso nominale. L'indicazione si riferisce al valore in assenza di rifrazione, come dichiarato dal produttore del componente.

Nominal luminous flux. It refers to the value without any refraction, as declared by the component manufacturer.

L'unité SI de flux lumineux. L'indication correspond à la valeur en l'absence de réfraction, comme indiqué par le fabricant du composant.

Die Maßeinheit für den Lichtstrom. Die Angabe bezieht sich auf den Wert in der Abwesenheit von Brechung, wie vom Hersteller der Komponente angegeben.

НОМИНАЛЬНЫЙ СВЕТОВОЙ ПОТОК. УКАЗАНИЕ ОТНОСИТСЯ К ЗНАЧЕНИЮ В ОТСУТСТВИЕ РЕФРАКЦИИ, КАК ЗАЯВЛЕНО ПРОИЗВОДИТЕЛЕМ КОМПОНЕНТОВ.

Flujo luminoso nominal. La indicación se refiere al valor sin refracción, como declarado por el fabricante del componente.

标称光通量。指示是指组件制造商声明的没有折射的值。

التدفق الضوئي الاسمي. يشير المؤشر إلى القيمة في حالة عدم وجود انكسار للضوء، كما هو مُعلن من قبل الشركة المصنعة للعنصر.

MASIERO

Masiero si riserva il diritto di apportare ai propri articoli, senza nessun preavviso, qualsiasi modifica ritenesse opportuna.

Masiero reserves the right to introduce any changes to its own products, without notice in advance.

Masiero se réserve le droit d'apporter une quelconque modification à les modèles sans préavis.

Masiero behält sich das Recht vor Änderungen vorzunehmen, ohne sofortige Benachrichtigung.

КОМПАНИЯ MASIERO ОСТАВЛЯЕТ ЗА СОБОЙ ПРАВО БЕЗ ПРЕДВАРИТЕЛЬНОГО УВЕДОМЛЕНИЯ, ЕСЛИ ЭТО БУДЕТ СОЧТЕНО ЦЕЛЕСООБРАЗНЫМ, ВНОСИТЬ В СОБСТВЕННЫЕ МОДЕЛИ ЛЮБЫЕ ИЗМЕНЕНИЯ.

Masiero se reserva el derecho de aportar modificaciones consideradas oportunas a sus artículos sin preaviso.

Masiero 保留对其认为适当的任何更改的权利, 恕不另行通知。

تحتفظ شركة مازيرو "Masiero" بالحق في إجراء أي تعديلات تراها مناسبة على منتجاتها، دون إشعار مسبق.

Masiero srl

via Peschiere, 53
31032 Casale sul Sile
Treviso, Italy
T +39 0422 7861
F +39 0422 786250

info@masierogroup.com
masierogroup.com

Design by Masiero
Photo, Studio Pointer
Print Italy, April 2021
by Grafica Antiga

